



Corporate Presentation

September 2021



Safe Harbor Statement

This presentation includes forward-looking statements about, among other things, Verastem Oncology's programs and product candidates, including anticipated regulatory submissions, approvals, performance and potential benefits of Verastem Oncology's product candidates, that are subject to substantial risks and uncertainties that could cause actual results to differ materially from those expressed or implied by such statements. Applicable risks and uncertainties include the risks and uncertainties, among other things, regarding: the success in the development and potential commercialization of our product candidates, including defactinib in combination with VS-6766; the occurrence of adverse safety events and/or unexpected concerns that may arise from additional data or analysis or result in unmanageable safety profiles as compared to their levels of efficacy; or our ability to obtain, maintain and enforce patent and other intellectual property protection for our product candidates.

Additional information regarding these factors can be found in Verastem Oncology's Annual Report on Form 10-K for the fiscal year ended December 31, 2020 and in any subsequent filings with the SEC, including in the sections thereof captioned "Risk Factors" and "Forward-Looking Information and Factors that May Affect Future Results," as well as in our subsequent reports on Form 8-K, all of which are filed with the U.S. Securities and Exchange Commission (SEC) and available at www.sec.gov and www.verastem.com.

The forward-looking statements in this presentation speak only as of the original date of this presentation, and we undertake no obligation to update or revise any of these statements.

Verastem Oncology

Well Positioned to Capitalize on Growth Opportunities

We are a biopharmaceutical company committed to developing and commercializing new medicines for patients battling cancer

New lead clinical program has best-in-class potential

VS-6766 (RAF/MEKi) and defactinib (FAKi) are clinically active against RAS mutant cancers

Rapid development paths to market

Validating clinical results achieved in low-grade serous ovarian cancer (LGSOC), strong signal in KRAS G12V mutant NSCLC; registration-directed trials initiated in 4Q 2020; FDA Breakthrough Therapy Designation in LGSOC

Significant downstream market opportunity and blockbuster potential

30% of all human cancers are driven by mutations in RAS family of genes; VS-6766 combinations potentially broadly applicable across a variety of tumor types, with preclinical synergy shown with an extensive number of agents including KRAS G12C inhibitors

Strong balance sheet

Monetization of COPIKTRA® (duvelisib) provides funding of current programs until at least 2024

Cash Balance of \$114.1 million, as of June 30, 2021

Debt reduced from approx. \$185M to \$0M (2019-2021)

Annual operating expense forecast of approximately \$55-60 million

Verastem Oncology Strategic Transformation

- **January 2020: In-licensed global rights to VS-6766, best-in-class RAF/MEK inhibitor, from Chugai**
- **February 2020: PIPE financing based on data for new clinical program**
- **September 2020: Divested global rights to Copiktra to Secura Bio**
- **November 2020: Initiated registration-directed ph. 2 study in LGSOC**
- **December 2020: Initiated registration-directed ph. 2 study in NSCLC**
- **March 2021: LGSOC study updated to include KRAS wild type patients**
- **May 2021: FDA Breakthrough Therapy Designation granted for VS-6766 + Defactinib in LGSOC**
- **July 2021: Remaining outstanding debt retired**



VS-6766 RAF/MEK Inhibitor Program Overview

VS-6766 is a differentiated, best-in-class asset potentially applicable across multiple patient populations

- Unique dual RAF/MEK targeting mechanism of action
- Best-in-class safety & tolerability profile relative to marketed MEK inhibitors, with potential for combinability with agents from multiple target classes
- Novel intermittent dosing schedule; convenient oral regimen
- Promising signals of clinical activity in various RAS-driven cancers, including in patients whose tumors previously progressed on other MEK inhibitors
- Preclinical anti-proliferative activity across multiple MAPK pathway alterations (e.g. KRAS, NRAS, BRAF, NFI mt) and multiple solid tumor indications
- Strong preclinical and clinical synergy data in combination with other agents targeting RAS pathway and parallel pathways

High Priority Lead Indications with Multiple Growth Opportunities

High Priority Registration Indications

Registration-Directed Trials Initiated in 4Q20

- LGSOC^{1,2}
- KRAS^{G12V} NSCLC^{1,2}

Mutation Opportunities

- KRAS mutations^{1,2}
- BRAF & NRAS mutations^{1,2}
- NFI mutations²
- GNAQ mutations²

Additional Indication Opportunities

- Pancreatic^{1,2} (10 pt cohort initiated)
- KRAS mt endometrioid¹ (10 pts initiated)
- Uveal Melanoma² (IST initiated)
- Melanoma^{1,2}
- Colorectal^{1,2}

Other VS-6766 Combinations

- Everolimus^{1,2}
- KRAS G12C inhibitor²
- SHP2 or SOS1 inhibitor²
- CDK4/6 inhibitor²
- EGFR inhibitor²
- Anti-PD-1^{1,2}

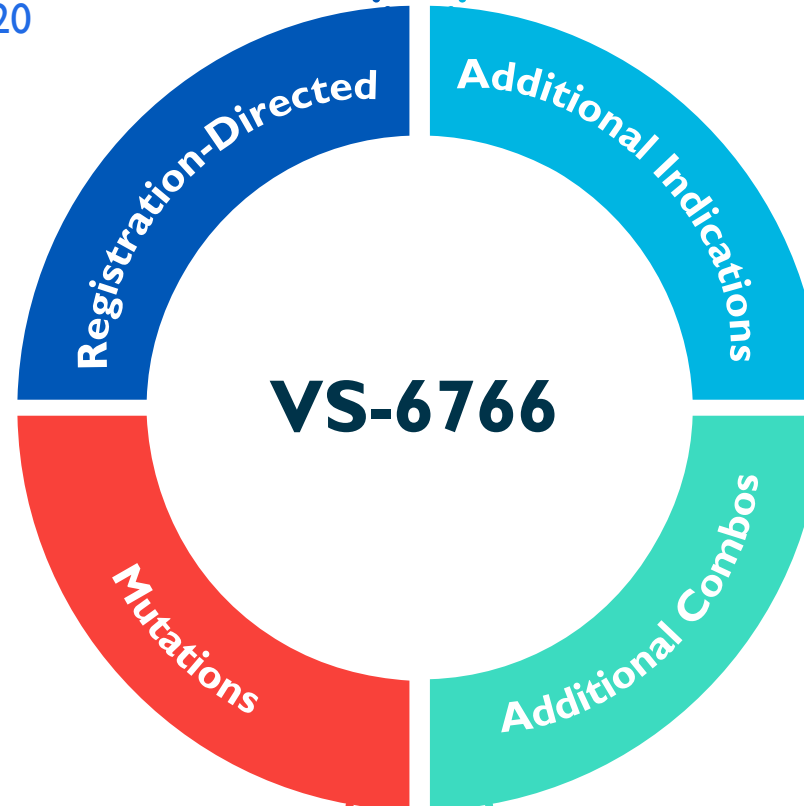

Robust Pipeline Targeting the RAS Pathway and Multiple Growth Opportunities

VS-6766 + DEFACTINIB	PRECLINICAL	PHASE 1	PHASE 2	PHASE 3	MARKET
RAMP-201¹ KRAS mt/wt LGSOC				<i>FDA Breakthrough Therapy Designation for VS-6766 + defactinib</i>	
RAMP-202¹ KRAS mt G12V NSCLC					
FRAME study Advanced LGSOC					
FRAME study Advanced KRAS mt NSCLC					
FRAME study Advanced CRC					
FRAME study Advanced KRAS-G12V mt NSCLC					
FRAME study Advanced pancreatic cancer					
FRAME study Advanced KRAS mt endometrioid cancer					
Metastatic uveal melanoma					

VS-6766 + OTHER COMBINATIONS	PRECLINICAL	PHASE 1	PHASE 2	PHASE 3	MARKET
KRAS mt NSCLC VS-6766 + everolimus (mTORi)					

KRAS mt NSCLC | VS-6766 + sotorasib (G12Ci) *Clinical Collaboration Initiated with **AMGEN***

¹ Registration-directed trial
 *Pre-clinical studies ongoing in multiple KRAS mutant tumors
 RAMP 201 study = NCT04625270
 RAMP 202 study = NCT04620330
 FRAME study = NCT03875820

VS-6766 is a Unique Small Molecule RAF/MEK Inhibitor

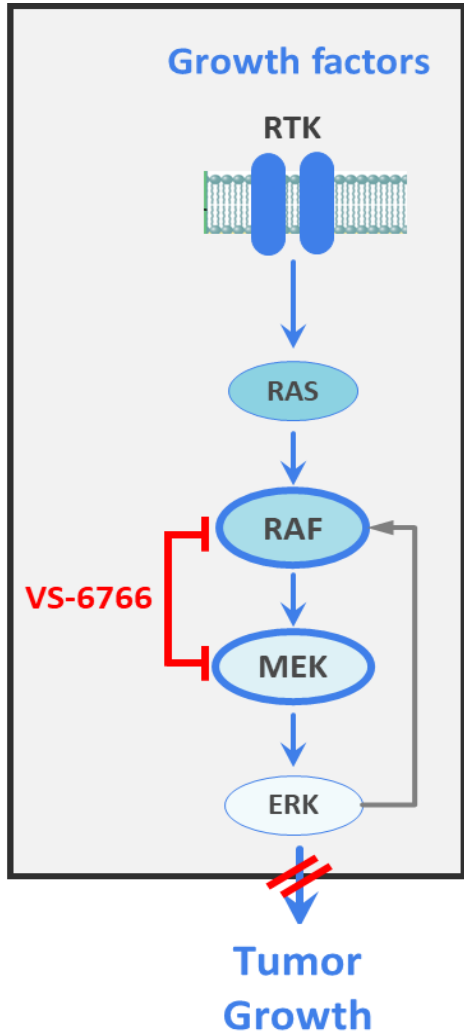

- VS-6766 inhibits both MEK & RAF kinase activities
- MEK inhibitors paradoxically induce MEK phosphorylation (pMEK) by relieving ERK-dependent feedback inhibition of RAF
- By inhibiting RAF phosphorylation of MEK, VS-6766 has advantage of not inducing pMEK
- VS-6766 inhibits ERK signaling more completely; may confer enhanced therapeutic activity

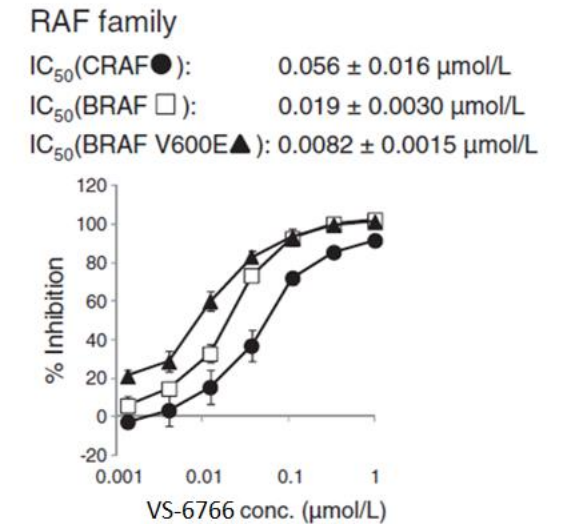
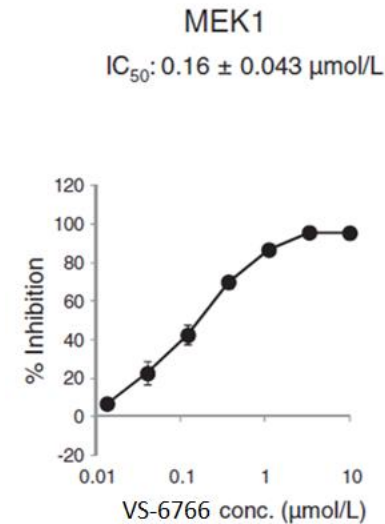

VS-6766 (RAF/MEKi)



Mirdametinib (MEKi)

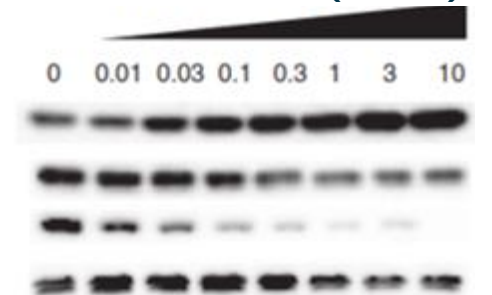

VS-6766 inhibits cell proliferation across multiple MAPK pathway alterations and multiple solid tumor indications

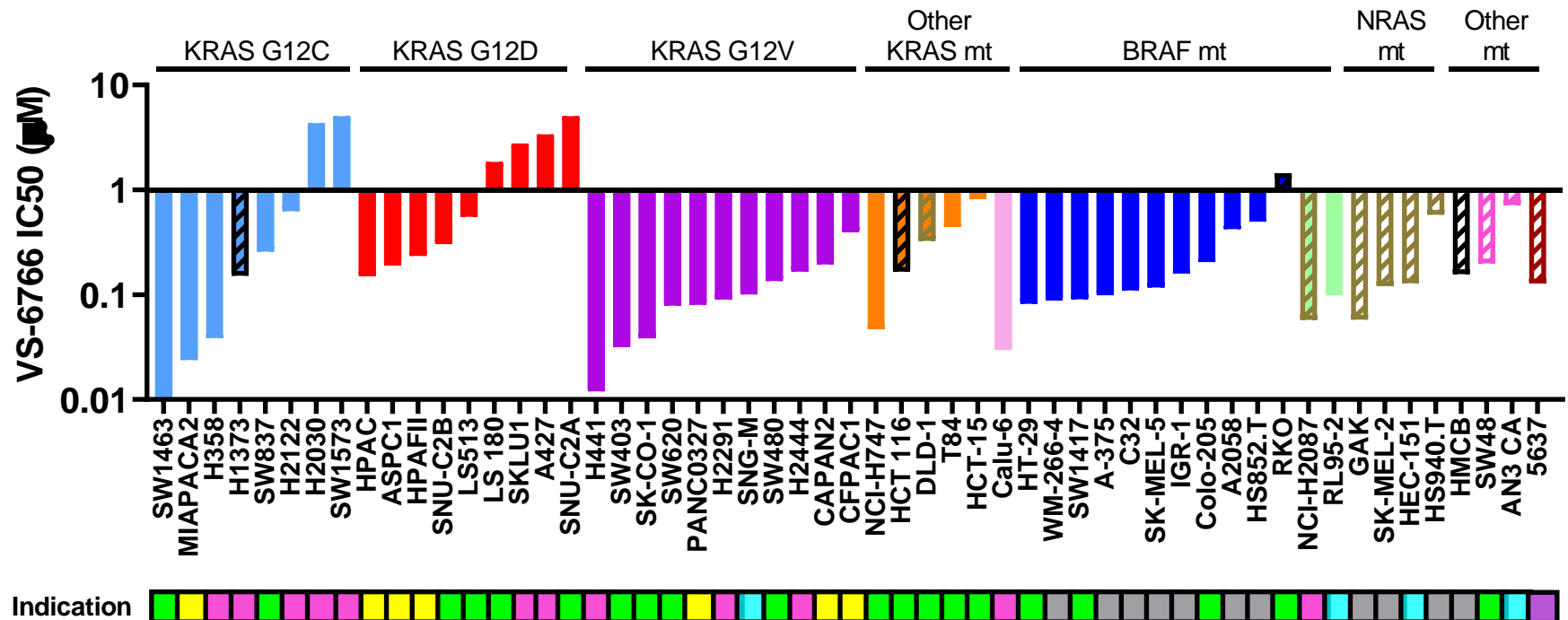

KRAS/BRAF/NRAS/NF1 status:		Indication:	
KRAS G12C	BRAF V600E	NSCLC	
KRAS G12D	BRAF class 2 mt	Panc	
KRAS G12V	NRAS mt	CRC	
KRAS G13D	NF1 mt	Melanoma	
KRAS Q61K	ARAF mt	Endometrial	
	ERK2 mt	Bladder	

Vertical Blockade: Establishing VS-6766 as the backbone of therapy for RAS pathway-driven tumors

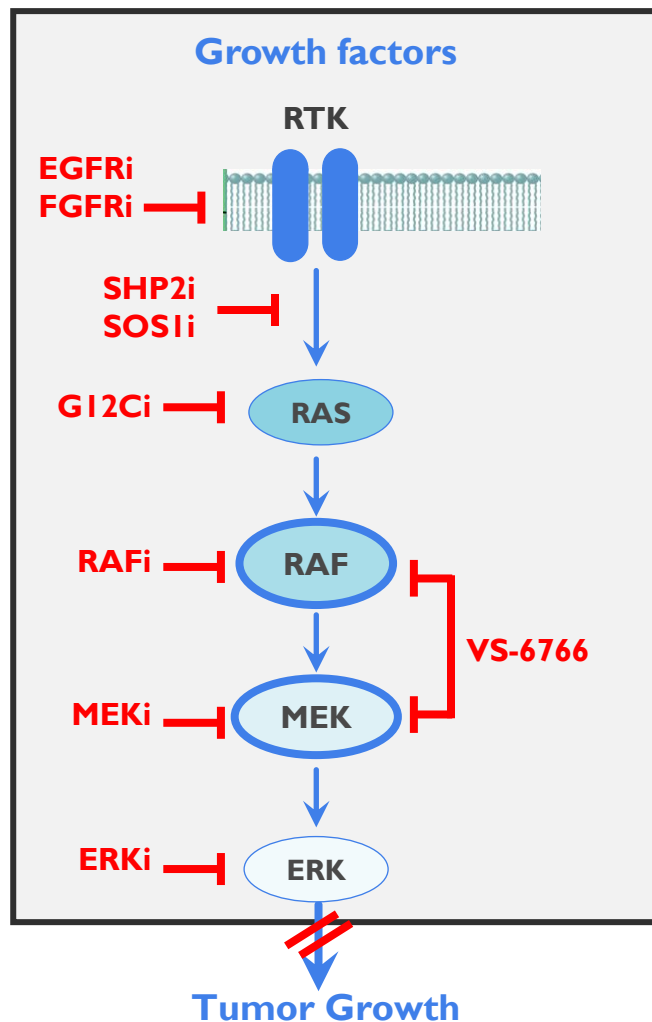

Current Challenges

- Blocking any single target in the pathway is insufficient for maximum depth and duration of anti-tumor efficacy
 - e.g., SHP2i, KRAS-G12Ci, RAFi, MEKi, ERKi
- Vertical blockade concept is now well established
 - Necessary to block more than 1 target in the pathway
- Many of these agents (e.g., SHP2i, MEKi) have poor tolerability as monotherapy and in combination

Solutions offered by VS-6766

- Vertical blockade (RAF and MEK blockade) in a single drug
- Best-in-class tolerability with established twice weekly dosing regimen
 - Should enable tolerable combinations
- Compelling synergy data (preclinical) for VS-6766 combinations (e.g., with KRAS-G12C inhibitors) supporting clinical combinations

Parallel Pathway Inhibition: Establishing VS-6766 as the backbone of therapy for RAS pathway-driven tumors

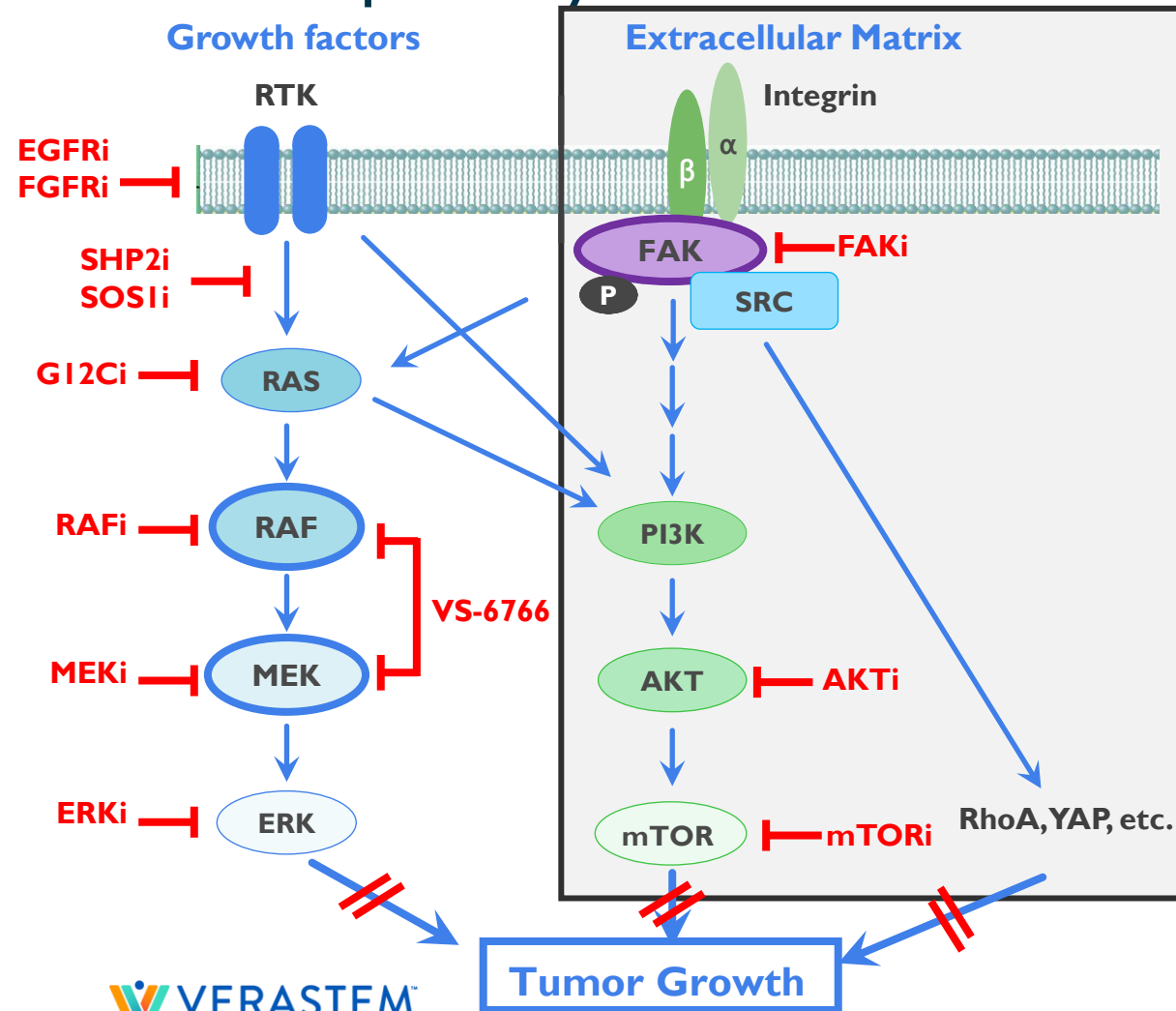

Current Challenges

- Blocking Ras pathway can be circumvented through parallel pathways
 - e.g., PI3K/AKT/mTOR, FAK, RhoA, YAP
- Combinations of MEKi + AKTi have shown poor tolerability

Solutions offered with VS-6766

- Good tolerability with twice weekly VS-6766 opens up intermittent dosing options for combinations
- Compelling preclinical synergy data with VS-6766 in combination with FAK inhibition and with AKT pathway inhibition (e.g., everolimus)
- RP2D established for VS-6766 + defactinib and for VS-6766 + mTORi (everolimus) with twice weekly regimen



VS-6766 +/- Defactinib in Low-
Grade Serous Ovarian Cancer

Favorable Tolerability Profile with Novel Intermittent Dosing Regimen

Summary of Adverse Events Grade ≥ 3 Occurring in $\geq 5\%$ of patients

	VS-6766 monotherapy Daily at MTD N=6 28-day cycle	RP2D VS-6766 monotherapy 4mg twice weekly N=26 28-day cycle	RP2D (VS-6766 3.2mg twice weekly + defactinib 200mg twice daily) N=38 21 days of 28-day cycle
Treatment Related Adverse Event	Grade ≥ 3	Grade ≥ 3	Grade ≥ 3
Rash	3 (50%)	5 (19%)	2 (5%)
CK elevation (Creatine phosphokinase)	1 (17%)	2 (8%)	2 (5%)

Summary of FRAME Safety Profile

Most Adverse Events (AE) were Grade 1/2

Few patients have discontinued due to AEs in the study

Favorable Tolerability Profile at Recommended Phase 2 dose for VS-6766 plus defactinib combination regimen

Treatment Related Adverse Events Details* (≥10% patients in cohort 3.2mg 6766 and Def 200mg)	VS-6766 4mg Twice Weekly (4 wks of every 4 wks) ¹ n=22		VS-6766 3.2mg Twice Weekly Def 200mg BID (3 wks of every 4 wks) ² n=38	
	Gr1/2	Gr3/4	Gr1/2	Gr3/4
Rash	15	5	32	2
CK Elevation	13	2	19	2
AST Elevation	1		13	
Hyperbilirubinemia			14	1
Visual Disturbance	13		9	
ALT Elevation	2		5	
Diarrhoea	6	1	14	1
Fatigue	5	1	8	1
Oral Mucositis [^]	7	1	11	
Nausea	5		5	
Vomiting	2		4	
Peripheral Edema	9		10	
Paronychia	3		4	
Thrombocytopenia			6	
Pruritus	3	0	5	

Summary of FRAME Safety Profile

- Most Adverse Events (AE) were Grade 1/2
- Few patients have discontinued due to AEs in the study

RP2D

- **VS-6766 3.2 mg** oral twice wkly (3 wks of every 4 wks)
- **Defactinib 200 mg** oral BID (3 wks of every 4 wks)

*AEs were graded by NCI CTC v4; highest grade only recorded for each patient; AEs presented in ≥10% Patient (cohort 3.2mg 6766 and Def 200mg) data preliminary and subject to change;

[^]also includes glossitis/mouth ulcers

VS-6766 in Combination with Defactinib Shows Promising ORR with Durability in Refractory LGSOC with Expanded Number of Patients (n=24)

Response by RECIST

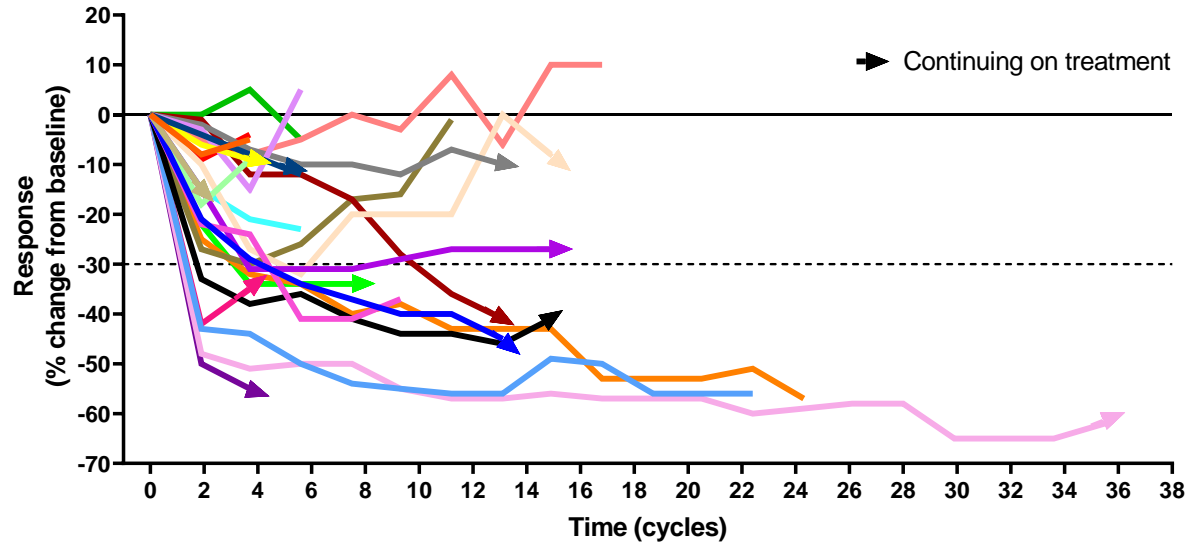

Best response by RECIST

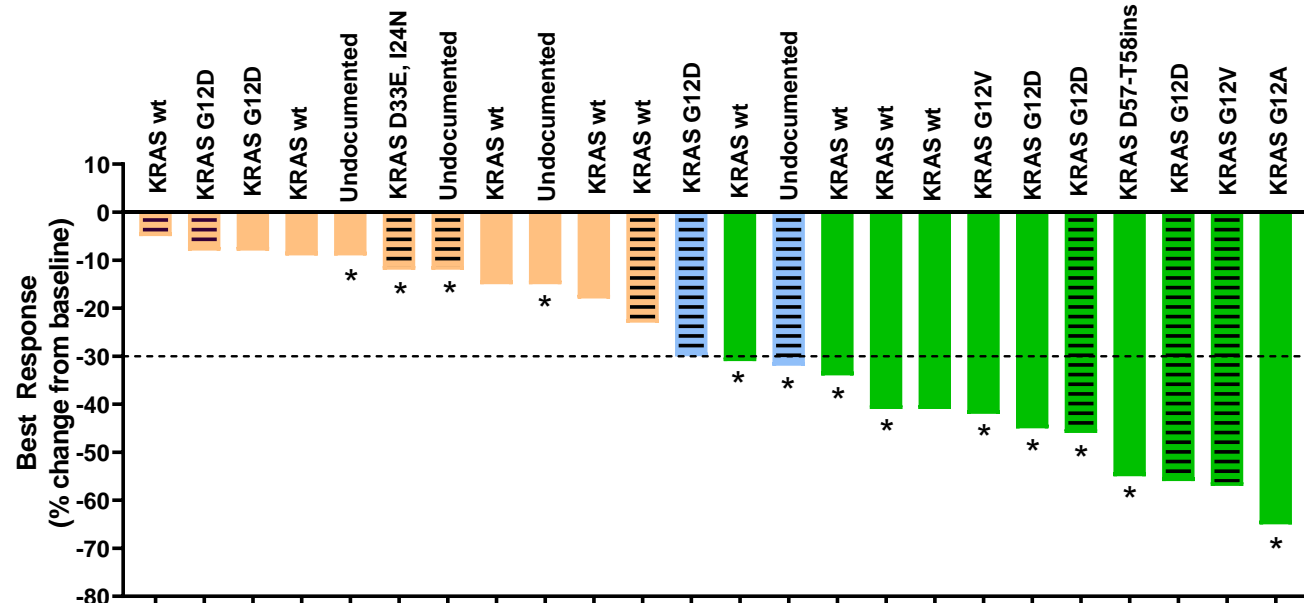

- Overall response rate (ORR) = 46% (11 confirmed PRs/24)
 - KRAS mutant ORR = 64% (7 confirmed PRs/11)
 - KRAS wild-type ORR = 44% (4 confirmed PRs/9)
 - KRAS status undetermined (1 unconfirmed PR/4)
- Response too early to determine for 2 pts on study for ≤ 5 months
- Responses in patients previously treated with MEKi
- 54% (13/24) patients still on treatment
- 1 patient discontinuing for adverse events as of April 2021
- Median PFS 23 months (95% CI 10.6-NR) across all LGSOC

▬▬▬ Prior MEK inhibitor

* Still on treatment

■ Confirmed partial response

■ Unconfirmed partial response

■ Stable disease

Data cut off April 2021

PFS: Progression free survival

NR: Not reached

LGSOC: Limited Treatment Options with High Unmet Need

Low-Grade Ovarian Cancer – Treatment Algorithm¹

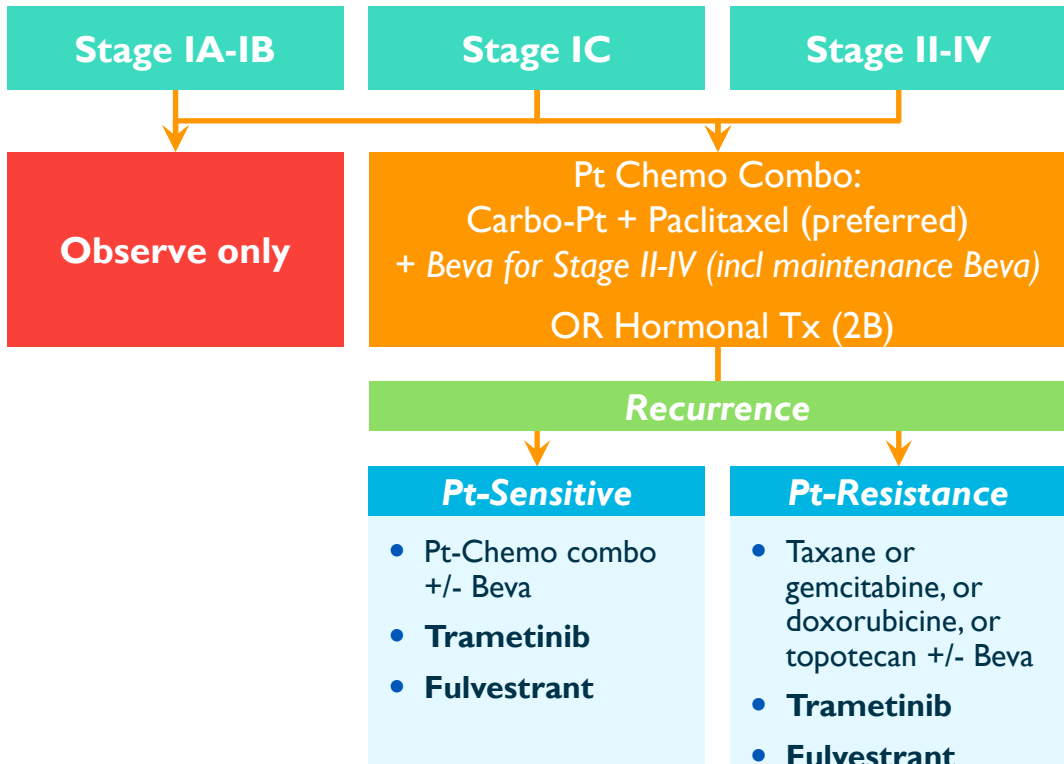

Therapy	Response Rate ORR	Median PFS Months (95% CI)	Discontinuation Rate due to AEs
Standard of Care ¹	6%	7.2 (5.6-9.9)	12 %
Trametinib ¹	26%	13.0 (9.9-15.0)	35%
Standard of Care ²	13%	10.6 (9.2 to 14.5)	17%
Binimetinib ²	16%	9.1 (7.3-11.3)	31%

References:
¹ NCCN guidelines

¹ Gershenson, et al. ESMO 2019.

² Monk et al., J Clin Oncol 2020.

Standard of Care = letrozole, tamoxifen, chemotherapy

PFS = Progression free survival

CI = confidence interval

70% of LGSOC tumors driven by mutations in the RAS pathway

LGSOC is a type of ovarian cancer that disproportionately affects younger women

1,000 to 2,000 patients in the U.S. and 15,000 to 30,000 worldwide diagnosed with LGSOC each year

A slow growing cancer, that has a median survival of almost 10 years, so patients remain in treatment for a long time (10-yr prevalence ~80,000 worldwide, ~6,000 US)

Patients often experience significant pain and suffering from their disease over time

Most prior research has focused on high grade serous ovarian cancer (HGSOC). However, LGSOC is clinically, histologically and molecularly unique from HGSOC with limited treatments available

~30% of LGSOC Patients Have KRAS mt
~70% of LGSOC Shows RAS Pathway-Associated mts

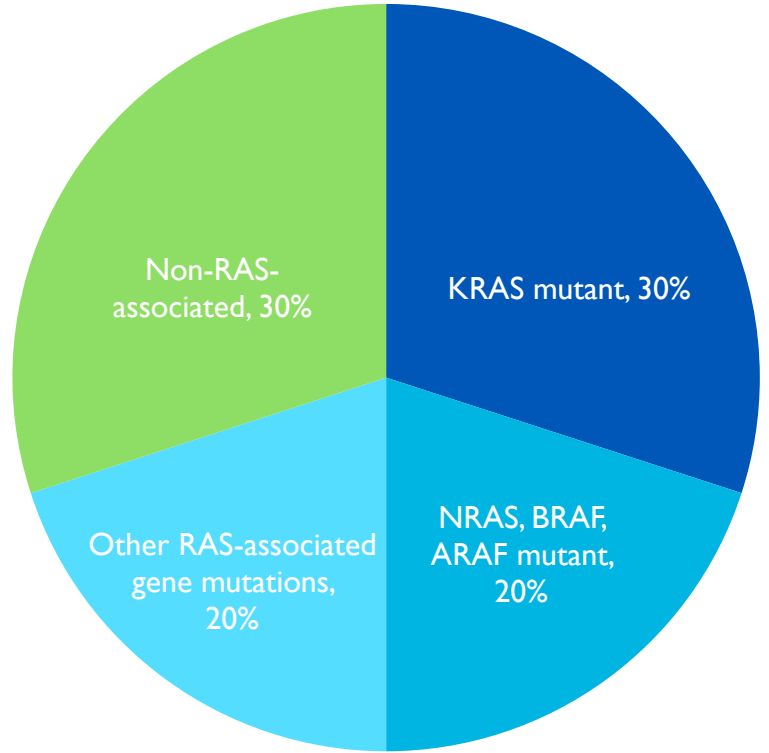

References: AACR Project GENIE Cohort v9.0-public and Verastem unpublished analysis

RAMP 201: KRAS Mutated (mt) and Wild Type (wt), Phase 2, Recurrent LGSOC Adaptive Design for Potential Accelerated Approval

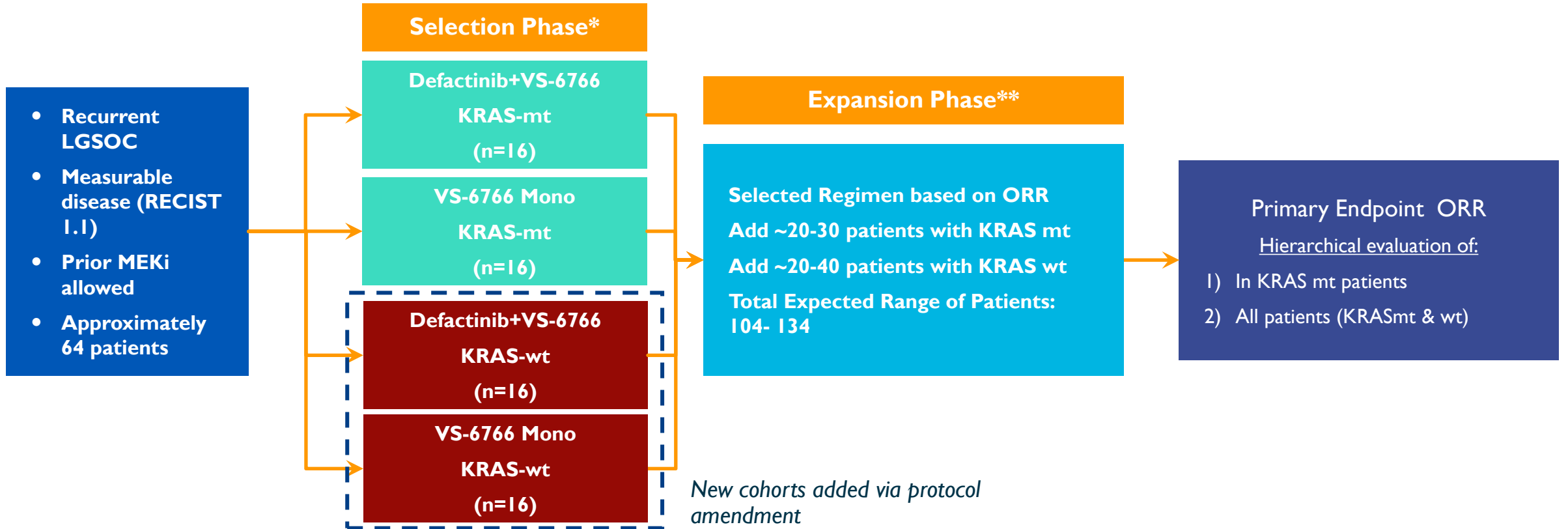

FDA Was Supportive of Development Strategy, Adaptive Design, and Addition of KRAS wt to Selection Phase

Registration-directed Study Commenced in Nov. 2020 with estimated Primary Completion Date for the Expansion Phase of June 2023 (clinicaltrials.gov)

LGSOC market opportunity larger or comparable to other high unmet need KRAS opportunities

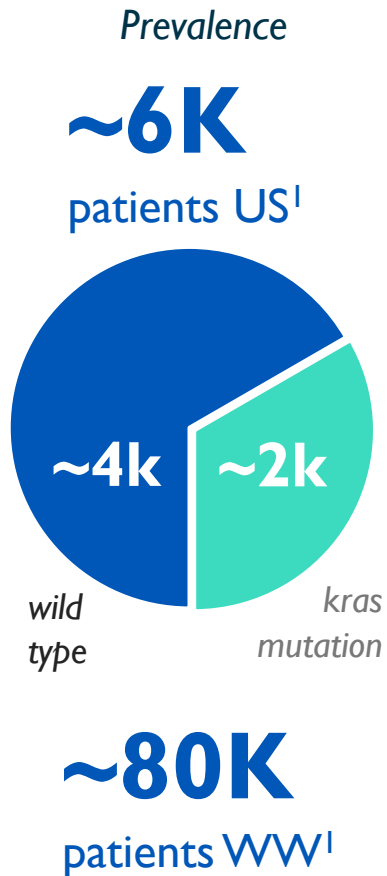

Patient-months of Therapy Per Year² (across all 2L+ patients)

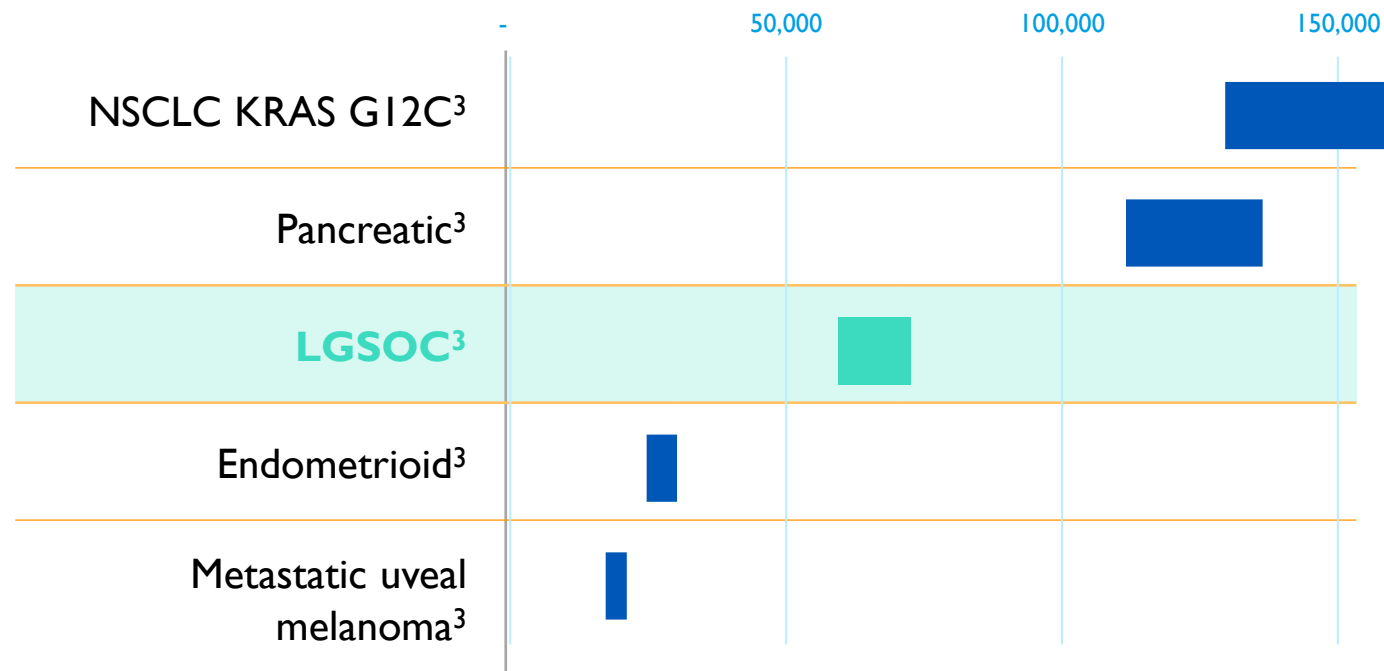

¹ References: Monk, Randall, Grisham, The Evolving Landscape of Chemotherapy in Newly Diagnosed Advanced Epithelial Ovarian Cancer, Am Soc Clin Oncol Educ Book; 2019; Slomovitz, Gourley, Carey, Malpica, Shih, Huntsman, Fader., Grisham et al, Low-Grade serous ovarian cancer: State of the Science; Gynecol Oncol; 2020. Grisham, Iyer, Low-Grade Serous Ovarian Cancer: Current Treatment Paradigms and Future Directions; Curr Treat Options Oncology; 2018; Globocan 2020

² Patient-months of Therapy metric calculated by multiplying relevant incidence/prevalence rate times estimated duration of therapy; represents US market opportunity only; patient population estimates from Globocan 2020, American Cancer Society 2021, AACR Genie Cohort V9.0 public, and scientific publications. Duration of therapy estimates from clinical studies and clinician experience. Patient-months on therapy is for 2nd-line+ patients

³ NSCLC KRAS G12C 2nd line patients (incidence); Pancreatic RAS/RAF mutant 2nd-line patients (incidence); LGSOC KRAS mutant and wild-type patients (prevalence); Endometrioid RAS/RAF mutant 2nd-line patients (incidence); Uveal melanoma RAS/RAF mutant 2nd-line patients (incidence)

VS-6766 +/- Defactinib in NSCLC

The slide features a red background on the left and a white background on the right. A large, stylized graphic on the right side consists of several diagonal stripes in red, blue, and teal, and a horizontal teal bar at the bottom right.

High Unmet Need in Refractory KRAS^m NSCLC Adenocarcinoma

NSCLC Adenocarcinoma³

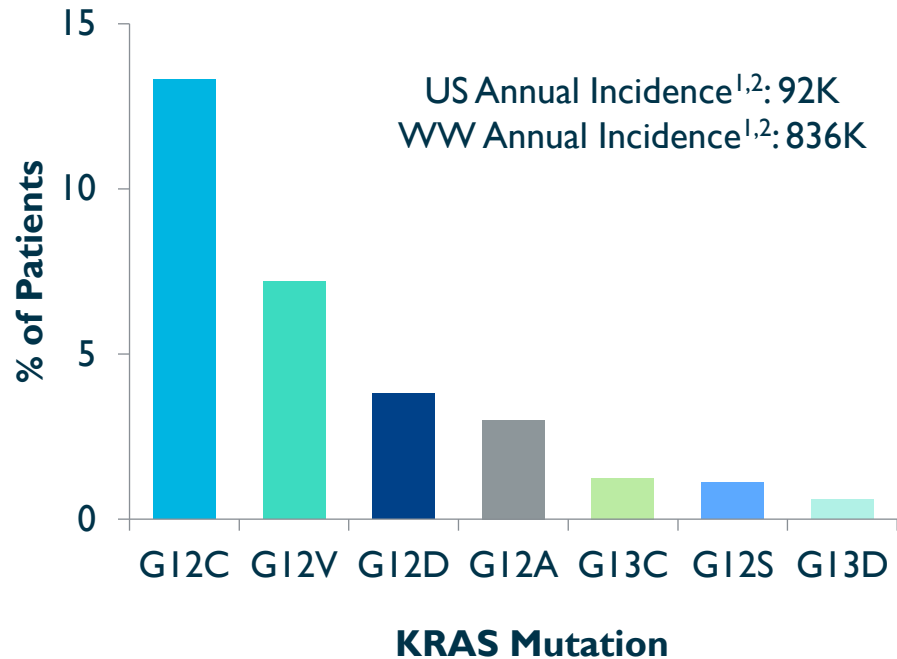

KRAS Mutations Represent 25% of Lung Cancer Adenocarcinoma (EGFR 17%, ALK 7%)⁴

References:

- ¹ Globocan, 2018
- ² <https://www.ncbi.nlm.nih.gov/books/NBK519578/>
- ³ TCGA PanCancer Atlas (cBioPortal analysis)
- ⁴ www.thelancet.com Vol 389 January 21, 2017
- ⁵ Adapted from NCCN Non-small cell lung cancer guidelines Version 3.2020

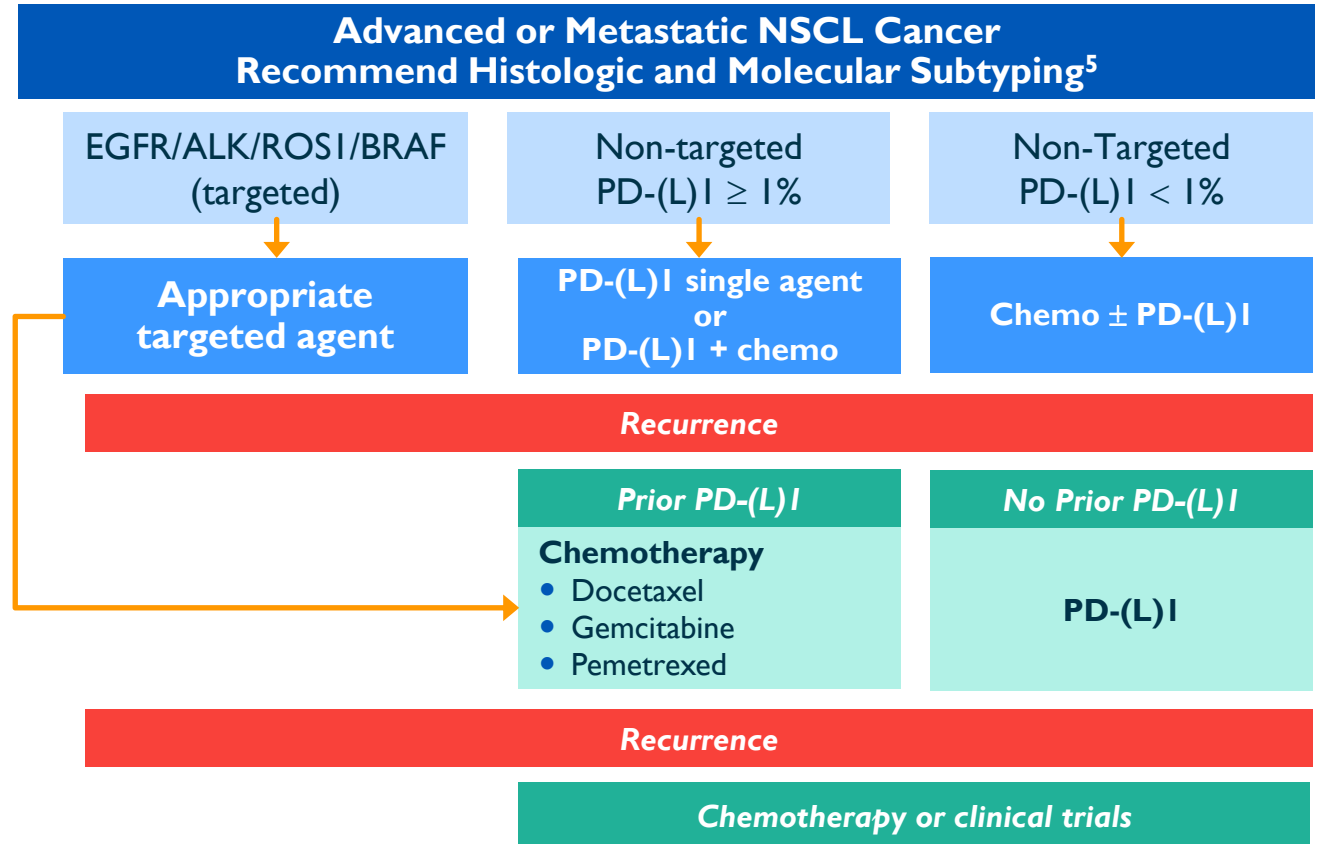

- SOC in recurrent disease is chemotherapy
- Pre-PD-(L)I era, chemotherapy response rate ~10% in recurrent disease; 12w PFS of 30–45%

VS-6766 Inhibits CRAF - The key driver of KRAS-G12V mutant NSCLC

A Precision Approach to KRAS-G12V Driven NSCLC

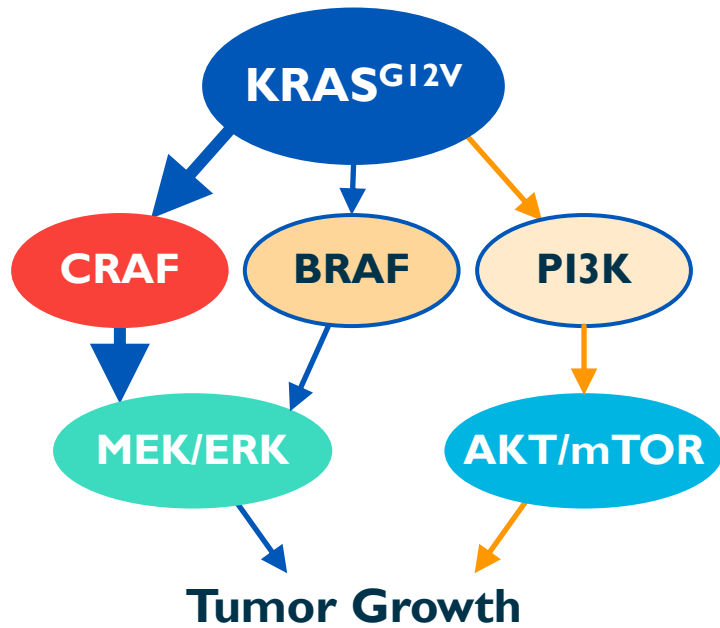

- KRAS^{G12V} signals mainly through RAF/MEK in contrast to other variants, such as KRAS-G12D, which signal more through PI3K/AKT
- KRAS^{G12V} models are especially dependent on CRAF

RAF family

IC₅₀(CRAF●): 0.056 ± 0.016 μmol/L
 IC₅₀(BRAF□): 0.019 ± 0.0030 μmol/L
 IC₅₀(BRAF V600E▲): 0.0082 ± 0.0015 μmol/L

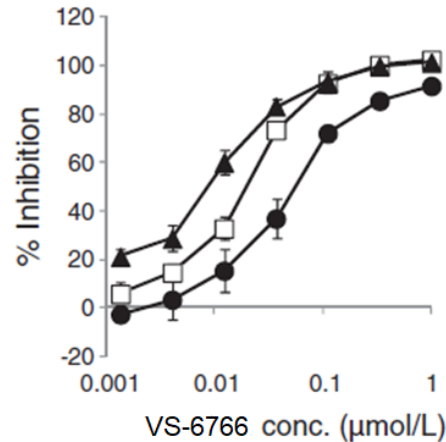

CRAF Drives KRAS G12V NSCLC¹

CRAF KO Shows Strong Efficacy

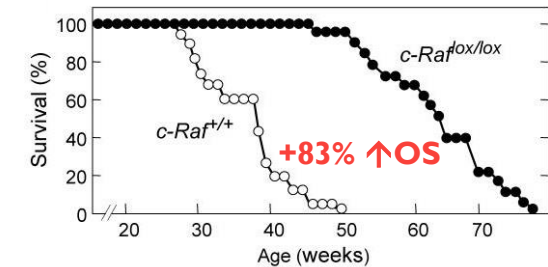

BRAF KO Has No Effect

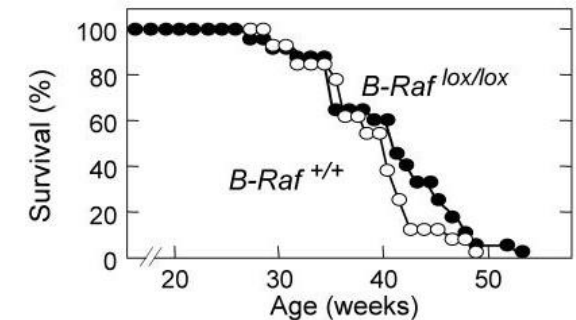

CRAF, but not BRAF, ablation improves survival of mice with KRAS^{G12V} induced lung cancer *in vivo*

VS-6766 +/- FAKi induces significant tumor regression in KRAS G12V mt NSCLC in vivo model, with clear differentiation from trametinib

KRAS G12V mutant; Tp53 KO NSCLC

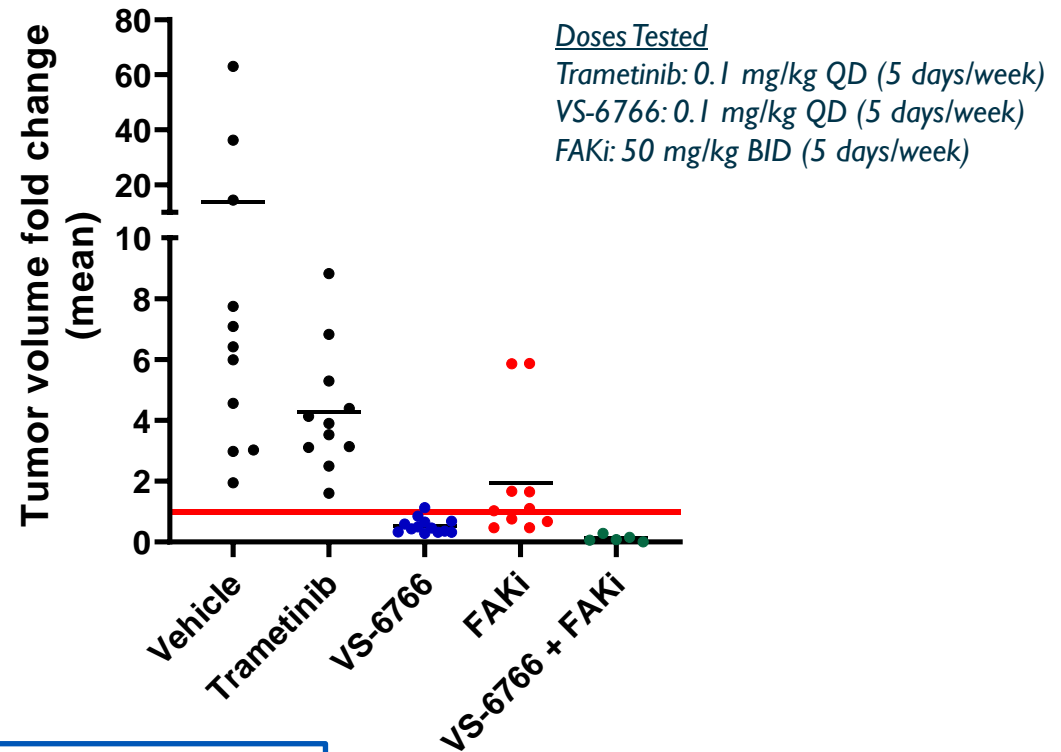
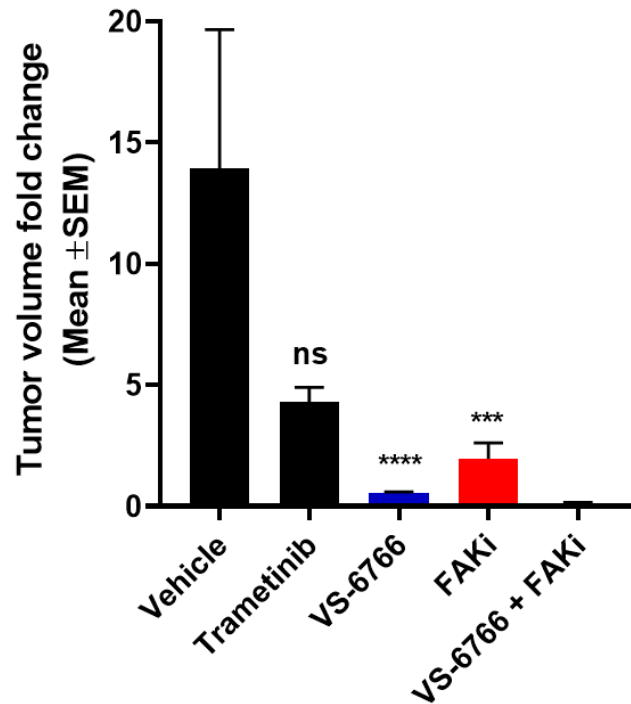

- VS-6766 monotherapy caused tumor regression
- VS-6766 + FAKi showed stronger regression
- No significant anti-tumor effect of trametinib at same dose level

4 weeks of treatment

Statistics: Mann-Whitney test

Collaboration with Mariano Barbacid

Case Study: Response to VS-6766 + defactinib in a patient with KRAS G12V mutant NSCLC

May 2019: Diagnosed with NSCLC

June 2019 - Sept 2019: Treated with first line Carboplatin + Pemetrexed + Pembrolizumab

Oct 2019: Progression, palliative RT to right hip

Nov 2019 – present: On treatment in FRAME study VS-6766 + Defactinib

Pre-treatment Oct 2019

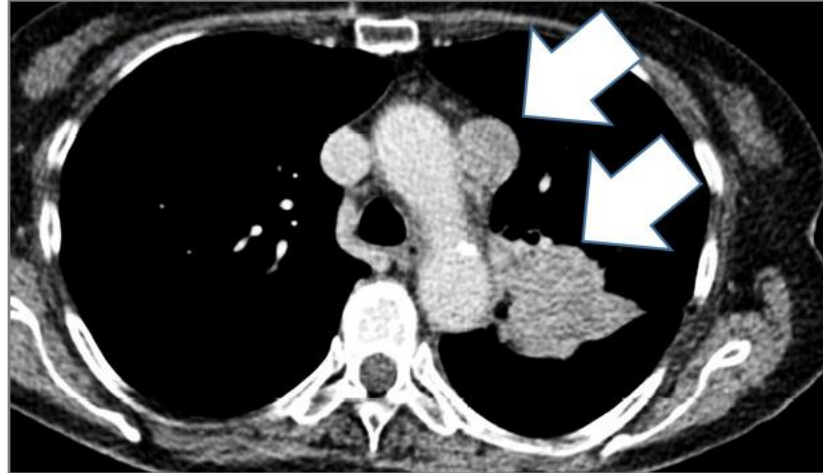

VS-6766 + Defactinib
On-treatment Feb 2021

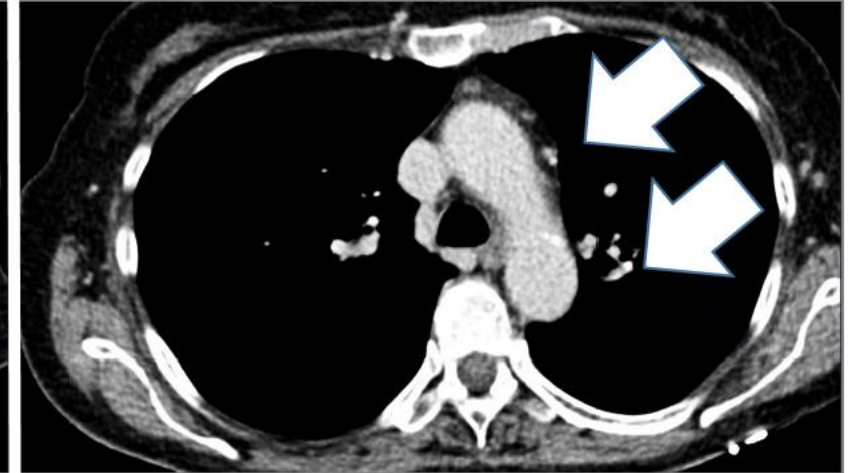

Strong Signal Identified in KRAS^{G12V} to Be Further Validated

VS-6766 ± Defactinib Has a Confirmed 57% ORR in KRAS^{G12V} NSCLC in Integrated Analysis

Best Response by RECIST in KRAS^{G12V} NSCLC

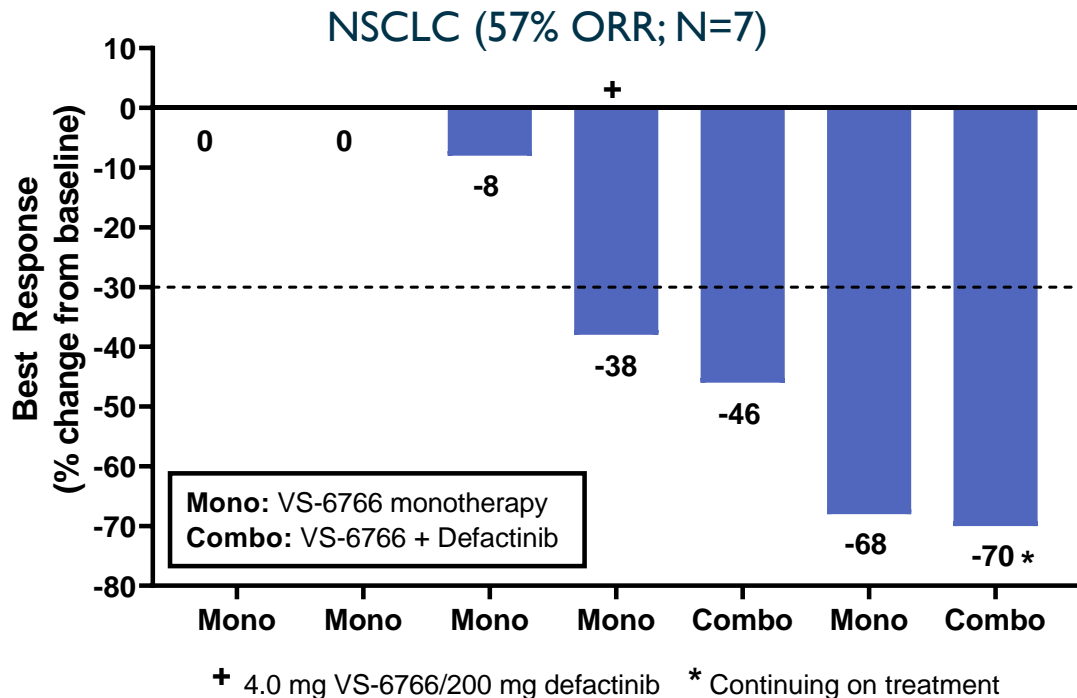

Time on Treatment for KRAS^{G12V} NSCLC

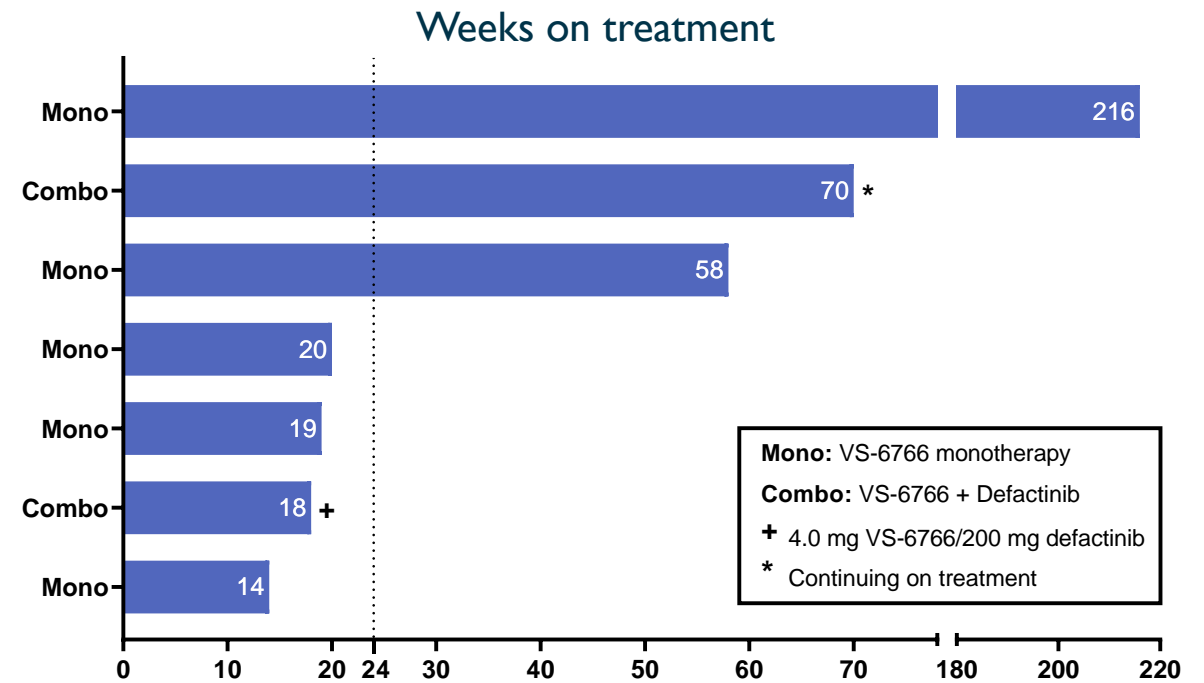

- Preclinical evidence suggests combination with Defactinib may improve efficacy in KRAS^{G12V} NSCLC
- Activity of VS-6766 as a single agent and in combo with Defactinib in KRAS^{G12V} NSCLC

NSCLC Clinical Strategy: KRAS Mutant (mt), Enriched G12V, Phase 2, Recurrent NSCLC for Potential Accelerated Approval

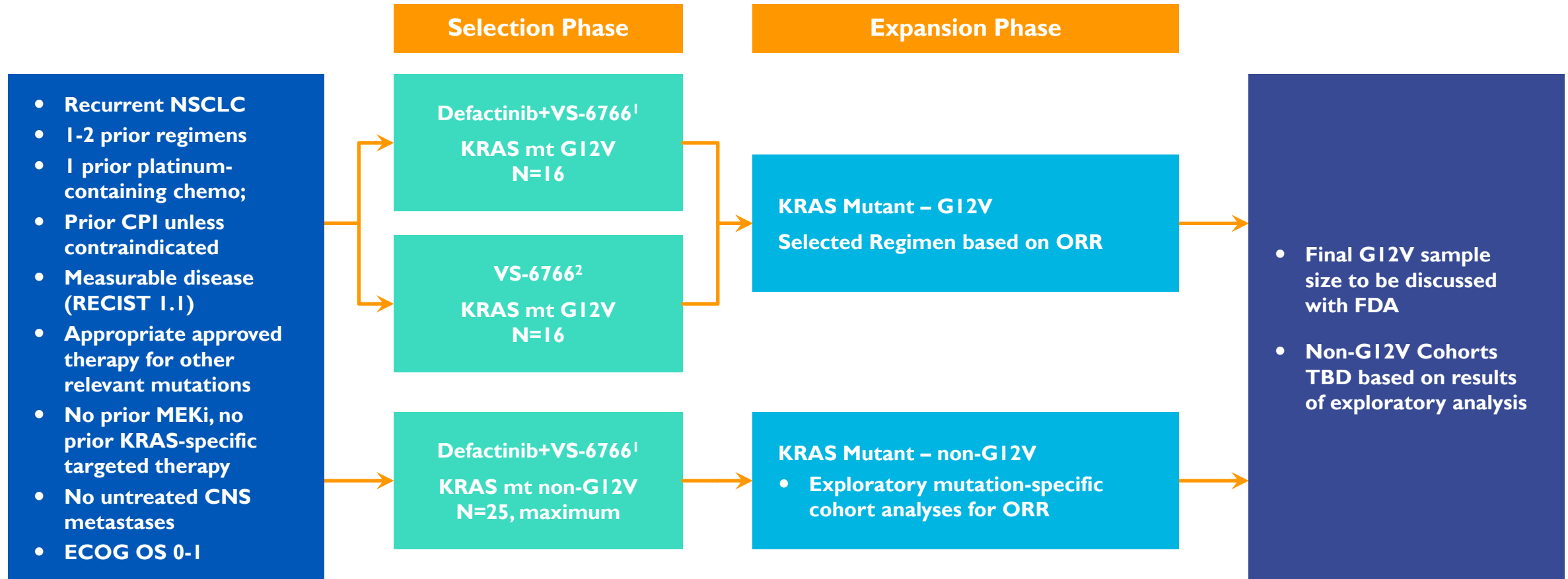

This Registration-directed Phase 2 Study commenced December 2020 with an estimated Primary Completion Date for the Expansion Phase of March 2023 (clinicaltrials.gov)

Preclinical synergy of VS-6766 + G12C inhibitors in KRAS G12C mt models

Synergy of VS-6766 + G12C inhibitor AMG 510 across G12C mutant NSCLC, CRC & Pancreatic cancer cell lines

Cell line	Indication	Sensitivity to G12C inhibitors	Combined Synergy Score	
			VS-6766 + AMG 510	VS-6766 + MRTX849
H2122	NSCLC	Moderately sensitive	44.7	44.6
H1373	NSCLC	Sensitive	10.0	3.4
SW1573	NSCLC	Insensitive	8.6	12.0
H358	NSCLC	Sensitive	6.9	5.4
H2030	NSCLC	Moderately sensitive	5.1	ND
SW837	CRC	Sensitive	16.1	18.5
MIAPACA2	Panc	Sensitive	2.3	5.3

ND: not determined

VS-6766 + AMG 510 yields deeper and more sustained inhibition of ERK signaling pathway

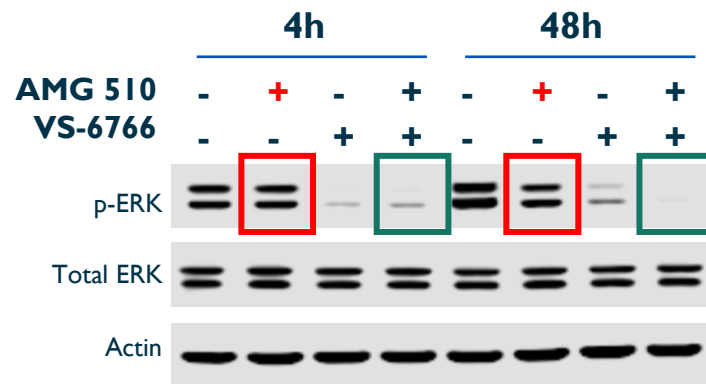

H2122 KRAS G12C mutant NSCLC

Concentrations Tested

AMG 510: 100 nM
VS-6766: 100 nM

VS-6766 & FAKi potentiate AMG 510 efficacy in KRAS G12C mutant NSCLC in vivo; Tumor regression in all mice with triple combination

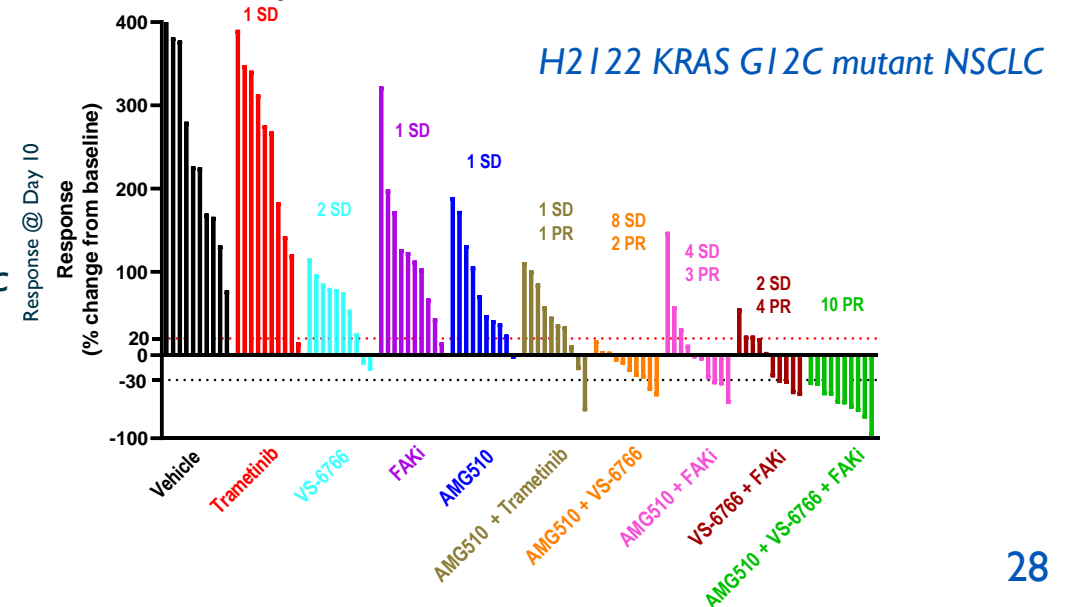
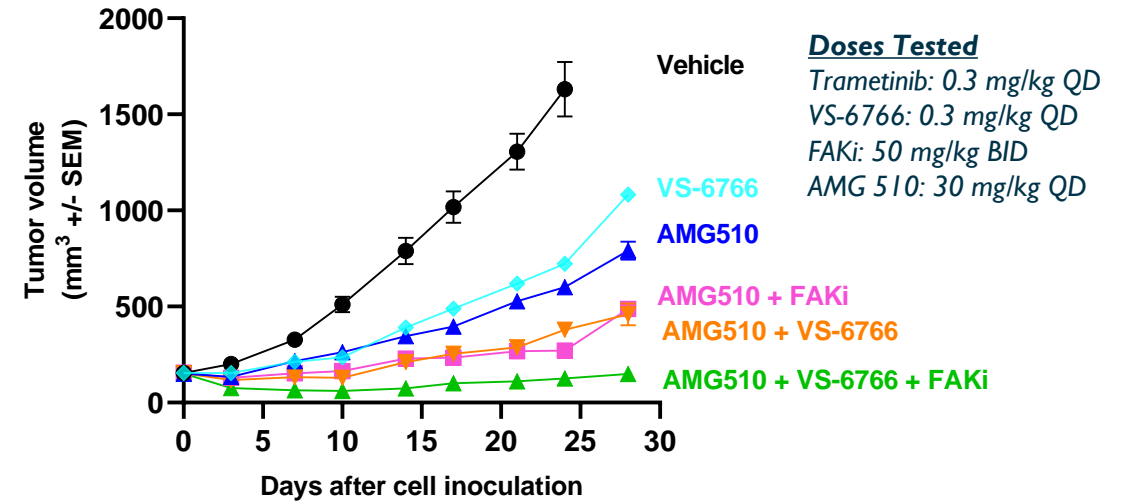

Acquired resistance mechanisms to KRAS G12Ci treatment in patients further support combination of KRAS G12Ci with VS-6766

Summary of Putative Mechanisms of Acquired Resistance to Adagrasib Treatment

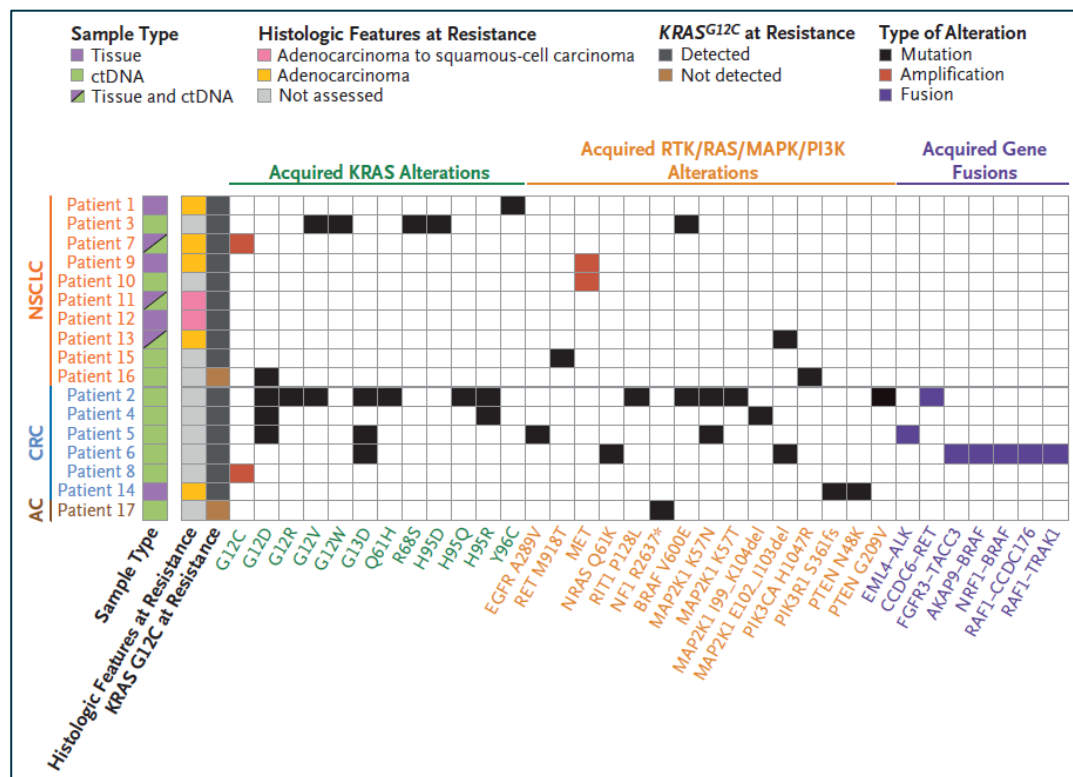

- Mechanisms of acquired resistance to KRAS G12Ci adagrasib treatment in patients recently reported^{1,2}
- The main resistance alterations occurred in
 - RTK mts or amplifications
 - KRAS mts or amplification
 - NRAS mt
 - BRAF V600E mt, BRAF or CRAF fusions
 - MAP2K1 (MEK1) mt/deletion
- VS-6766 is expected to be effective against these KRAS, NRAS, BRAF and CRAF modifications

We have just initiated a clinical collaboration with Amgen to explore the combination of VS-6766 + sotorasib in NSCLC KRAS G12C mt patients

- Patients must have known G12C KRAS mutation determined using validated test
- Treatment with at least 1 but no more than 3 prior systemic regimens, for Stage 3B-C or 4 NSCLC
- Patient may have previously received adjuvant chemotherapy for earlier-stage disease
- Measurable disease according to RECIST 1.1
- ECOG performance status ≤ 1

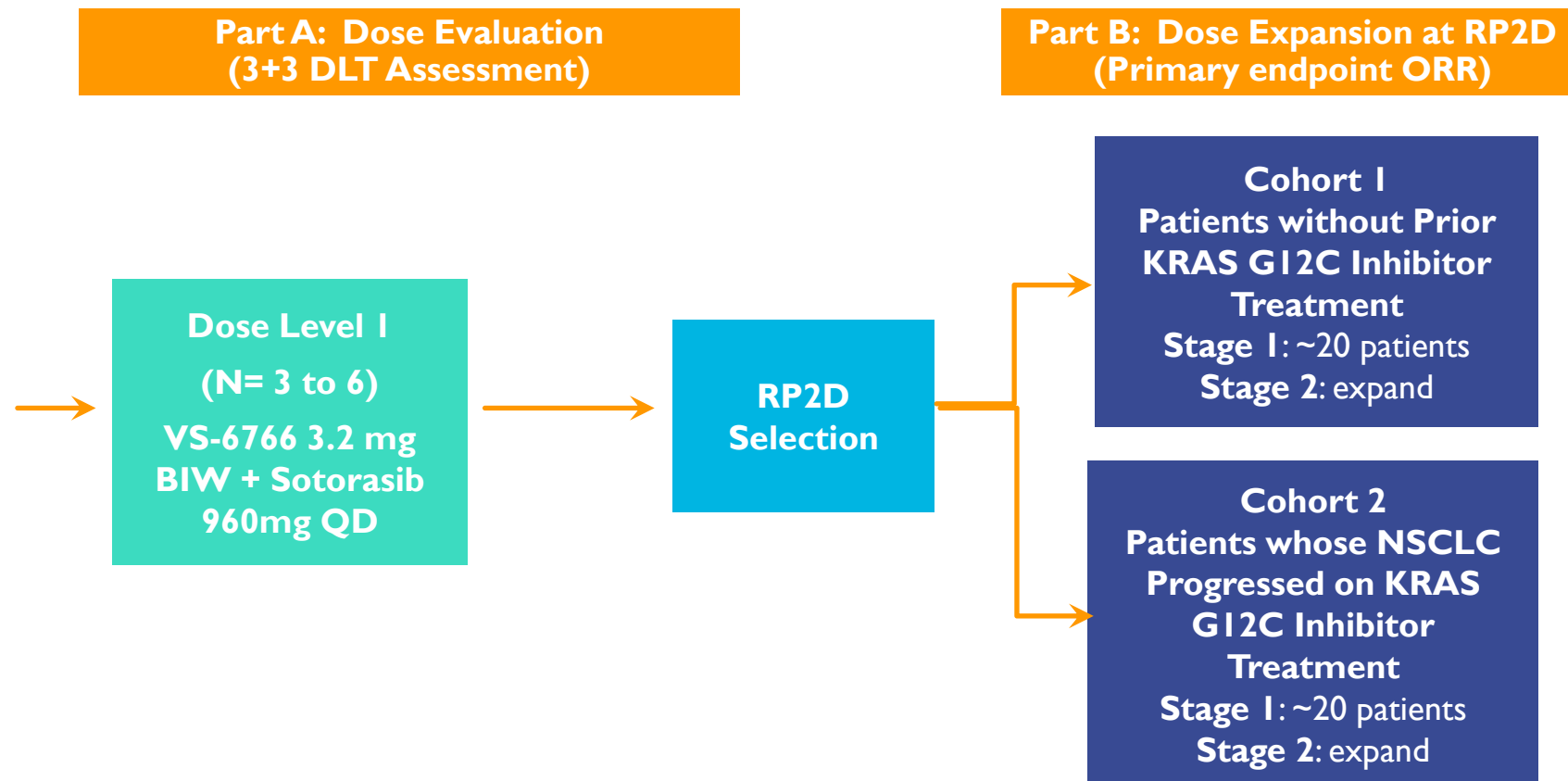

Part A (Dose Evaluation) portion of study expected to be initiated in 4Q 2021



Future Opportunities: VS-6766 as
Backbone of RAS Therapy

Vertical Blockade: Preclinical synergy in combination with several promising targets

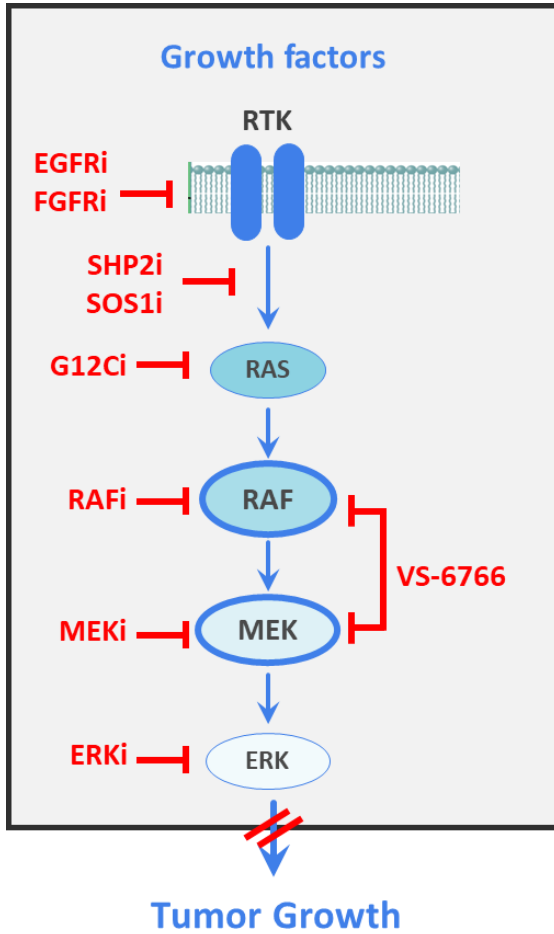

VS-6766 + pan-HERi (Afinib)

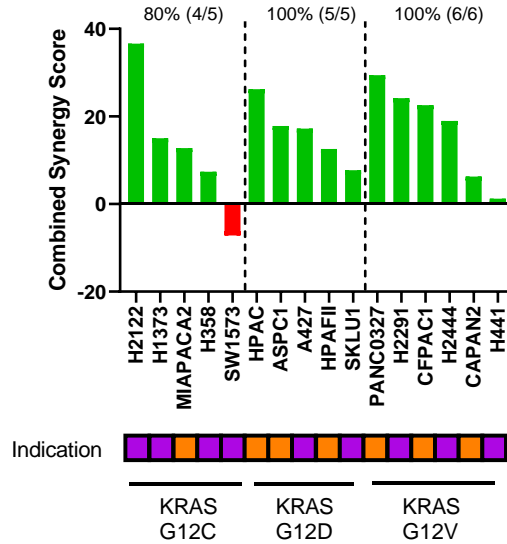

VS-6766 + SHP2i (RMC-4550)

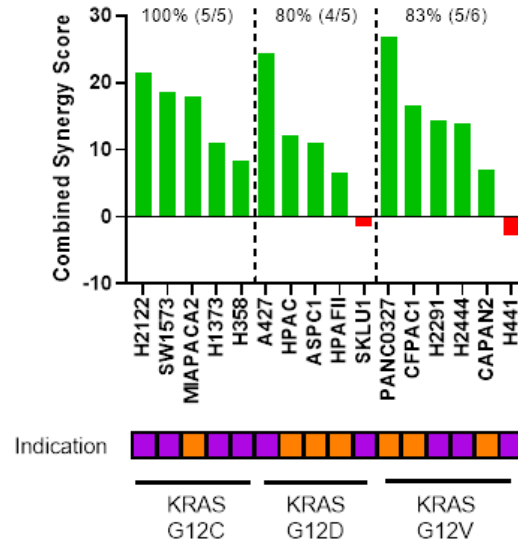

VS-6766 + SOS1i (BI-3406)

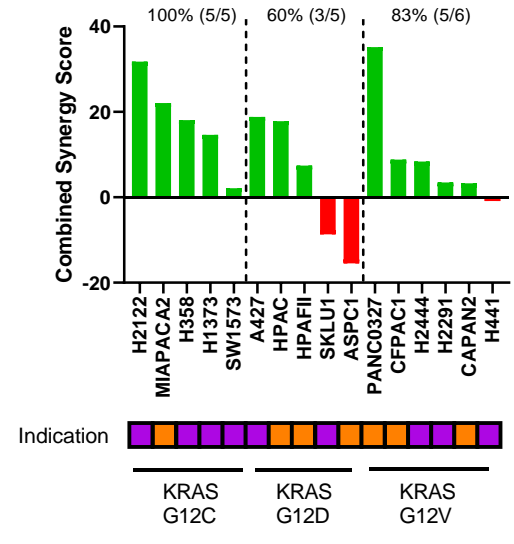

VS-6766 + G12Ci (AMG 510)

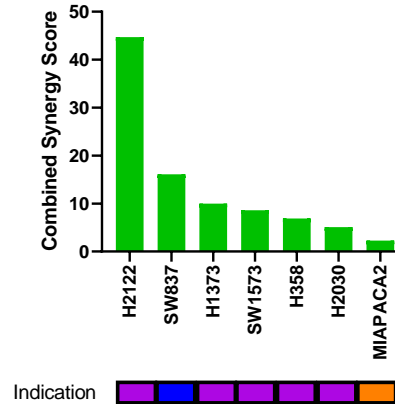

VS-6766 + G12Ci (MRTX849)

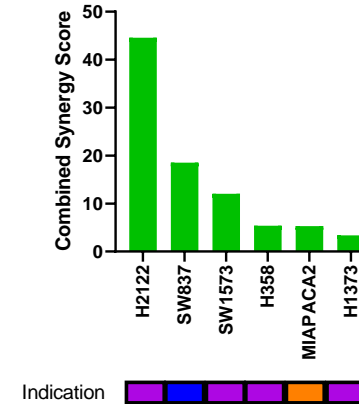

VS-6766 + ERK1/2i (LY3214996)

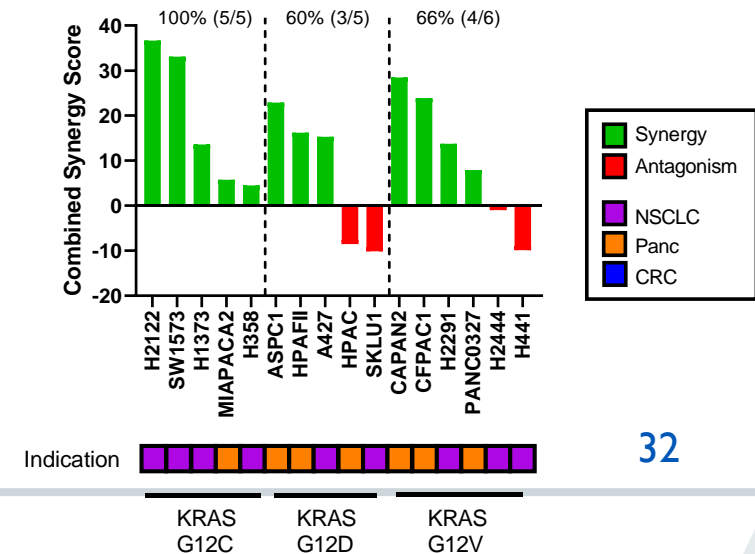

Parallel Pathway Inhibition: Two synergistic combinations already progressed to clinical stage

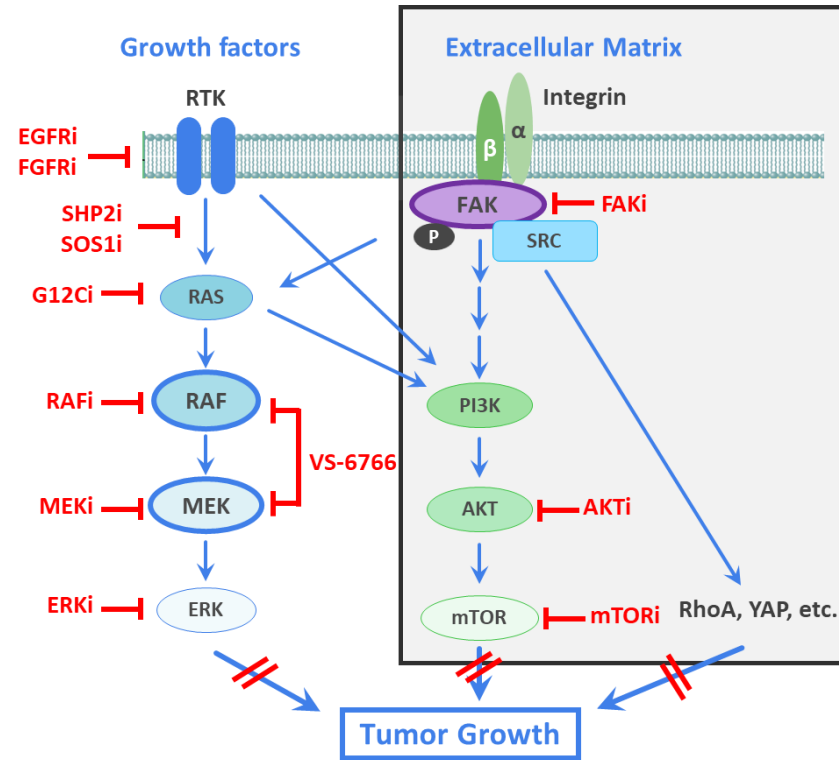

VS-6766 + p70S6K/AKTi (M2698)

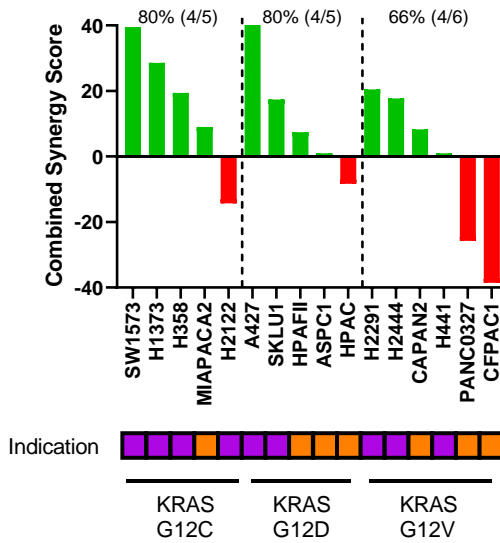

VS-6766 + mTORi (Everolimus)

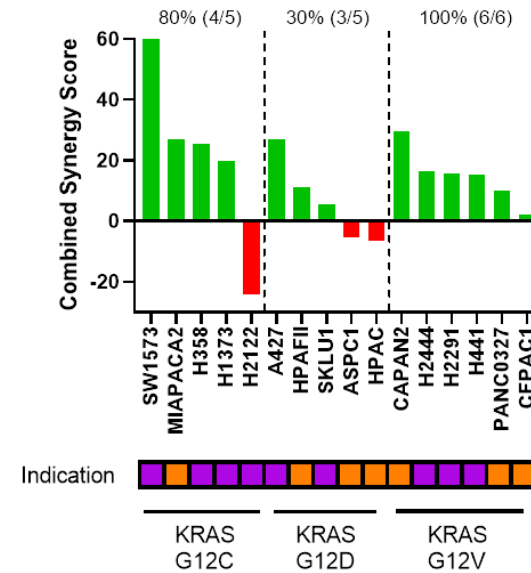

VS-6766 + FAKi (Defactinib)

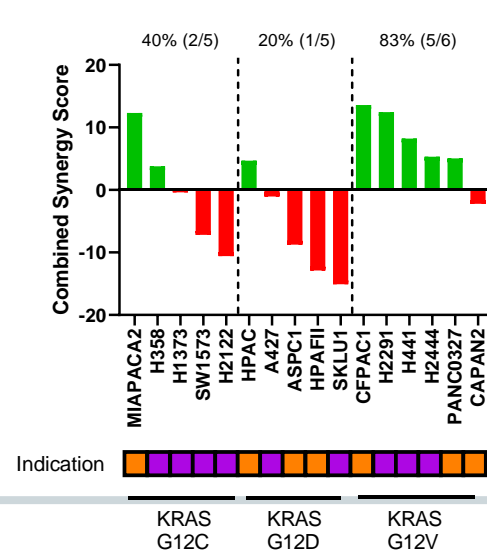

VS-6766 + CDK4/6i (Palbociclib)

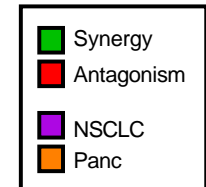
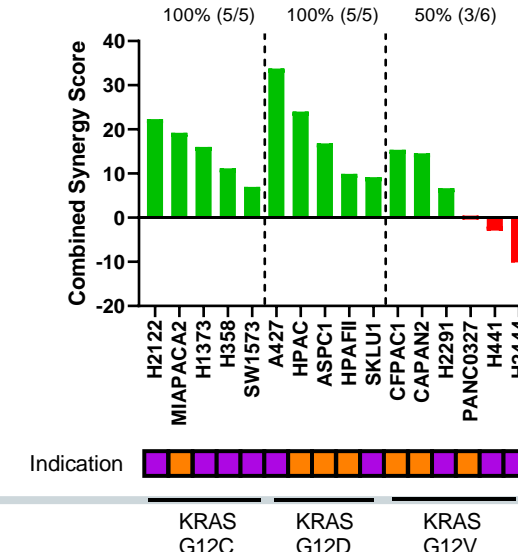

Corporate



Key VSTM Milestones 2020-2022

	IH2020	2H2020	IH2021	2H2021	IH2022
Corporate	<ul style="list-style-type: none"> VS-6766 In-Licensed from Chugai PIPE Financing for New Clinical Program 	<ul style="list-style-type: none"> Copiktra divested to Secura Bio 		<ul style="list-style-type: none"> Retired Outstanding Debt 	
LGSOC		<ul style="list-style-type: none"> RAMP-201 Study Initiated 	<ul style="list-style-type: none"> RAMP-201 Amended to Include KRAS wt patients in Selection Phase FDA Breakthrough Therapy Designation 	<ul style="list-style-type: none"> Updated data from FRAME LGSOC cohort Presenting at ESMO 	<ul style="list-style-type: none"> RAMP-201 Top-Line Data from Selection Phase & Initiate Expansion Phase
NSCLC		<ul style="list-style-type: none"> RAMP-202 Study Initiated 	<ul style="list-style-type: none"> Updated data from FRAME NSCLC cohort Presented at AACR 	<ul style="list-style-type: none"> VS-6766 + Sotorasib Collaboration w/Amgen 	<ul style="list-style-type: none"> RAMP-202 Top-Line Data from Selection Phase & Initiate Expansion Phase

Key Financial Statistics

As of June 30, 2021

Cash, cash equivalents & investments	\$114.1M
Shares fully diluted	196.2M
5.00% Convertible Senior Notes Due 2048 (2018 Notes)	\$0.3M*
5.00% Convertible Senior Notes Due 2048 (2020 Notes)	\$28.0M**
Insider ownership (outstanding / vested)	8.7% / 5.0%

* The 2018 Notes have an initial conversion rate of 139.5771 shares of Common Stock per \$1,000 which translates to an initial conversion price of \$7.16 per share of Common Stock.

** On July 16, 2021, all of the \$28.0 million aggregate principal of the 2020 Notes have converted into approximately 8.6 million common shares of the Company's common stock. As such, there is \$0 aggregate principal outstanding of 2020 Notes.

Backup Slides

The background features a large red area on the left and top. On the right side, there are several overlapping geometric shapes: a dark blue diagonal bar, a teal diagonal bar, and a teal horizontal bar with rounded ends. A dark blue horizontal bar is also present at the bottom left, overlapping the red area.

High Unmet Needs in RAS/RAF/MEK/ERK-Driven Cancers

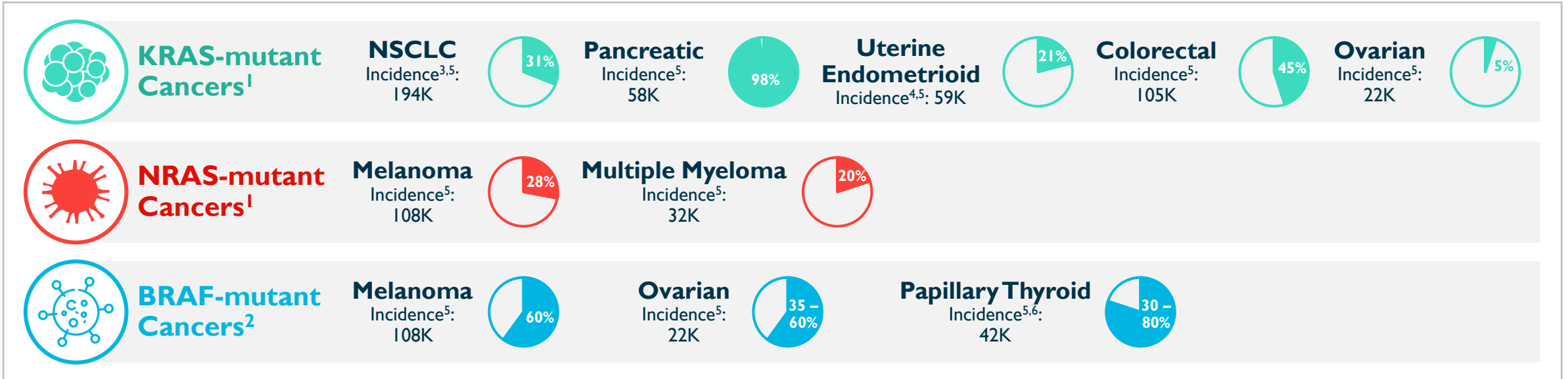

Breadth of potential opportunity

- 30% of all human cancers are driven by mutations of the RAS family of genes⁶

Established prognostic significance

- Patients with mutations of the RAS family have an overall worse prognosis

Challenges with conventional approaches

- Modest progress; limited number of approved therapies
- Single agent therapies (e.g., MEK inhibitors) associated with resistance
- Tolerable combination regimens with MEK inhibitors have been challenging
- Current RAS inhibitors in development address only a minority of all RAS mutated cancers

Incidence References:

¹Reference for RAS mt frequencies – Cox et al. *Nature Reviews* 13: 828, 2014; ²Reference for BRAF mt frequencies – Turski et al. *Mol Cancer Ther* 15: 533, 2016

³85% of lung cancer is NSCLC (Lu et al. *Cancer Manag Res*. 2019); ⁴90% of all uterine cancers are of the endometrial type (ACS); ⁵Cancer Statistics 2020, Siegel et. al. *CA Cancer J Clin* 2020;70:7-30; ⁶8 out of 10 thyroid cancers are of the papillary type (ACS)

References:

McCormick F *Clin Cancer Res* 15April2015; ⁶Adderley H et al. *EBioMedicine* 01Mar2019; Papke B et al. *Science* 17Mar2017; Ryan M et al. *Nature Reviews Clinical Oncology* 01Oct2018; NIH cancer.gov/research/key-initiatives/ras

KRAS G12V and G12D Represent ~50% of KRAS Mutations across Human Cancers

% frequency in a total of 780 cancer patients with KRAS mutations¹

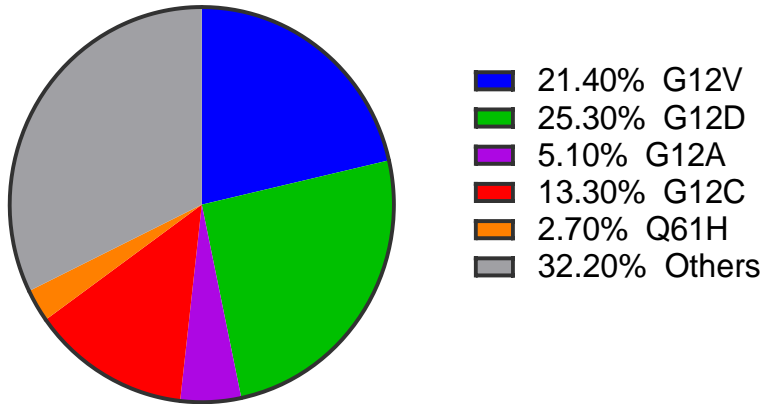

References:

¹ TCGA PanCancer Atlas (cBioPortal analysis)

² 90% of all uterine cancers are of the endometrial type (ACS)

³ Cancer Statistics 2020 (Siegel et al. CA Cancer J Clin 2020; 70:7-30)

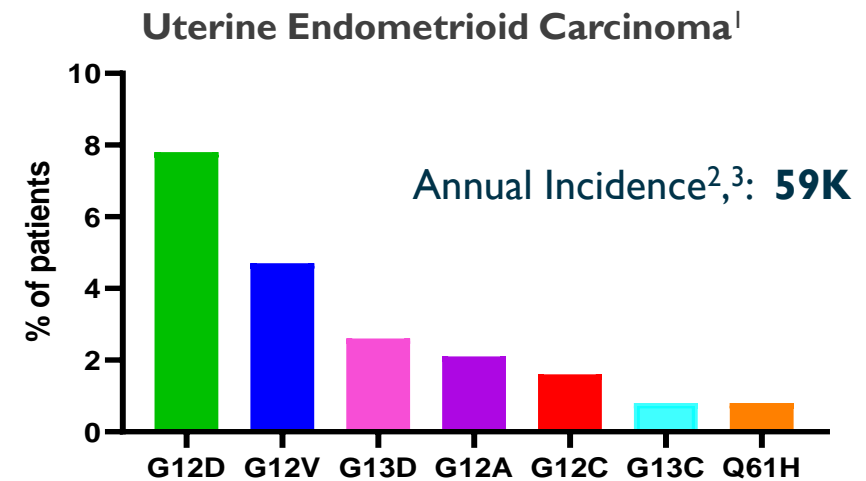
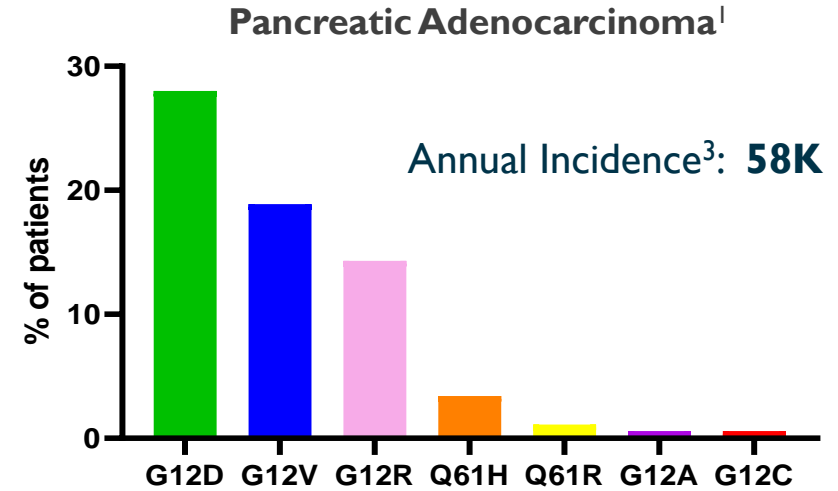

VS-6766 and FAK inhibitor combination leads to more robust anti-tumor efficacy in vivo

KRAS^{mut} Ovarian TOV-21G *in vivo* Model¹

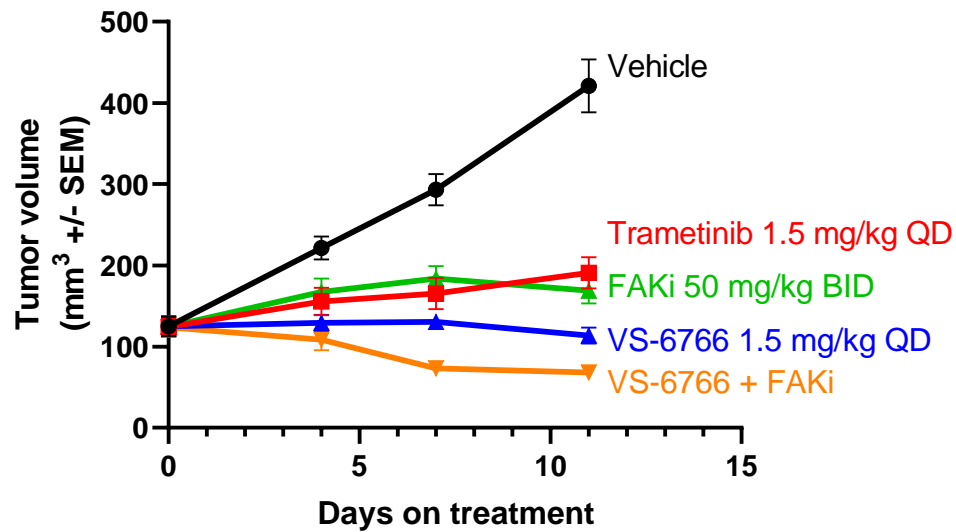

KRAS^{mut} NSCLC H358 *in vivo* Model²

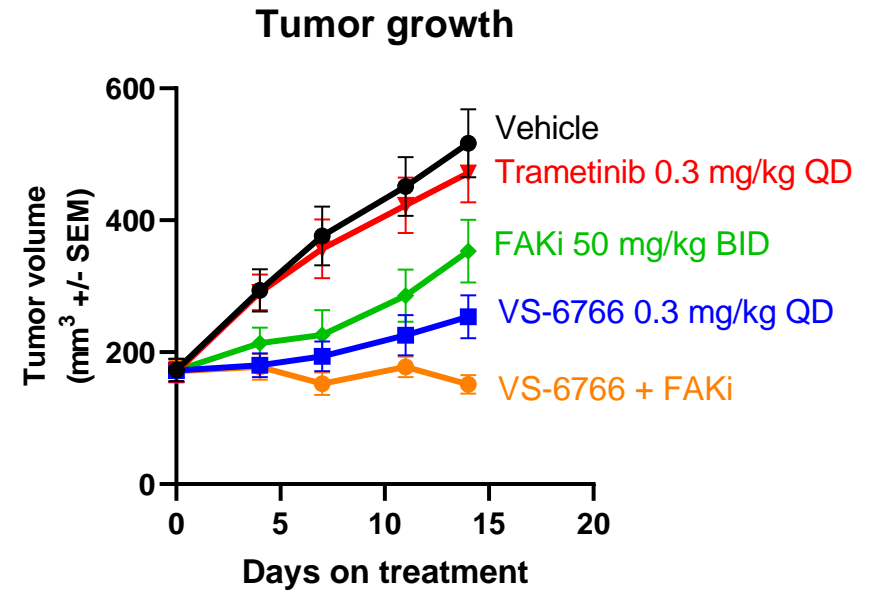

Overcoming Key Resistance Mechanisms to MEK Inhibitors

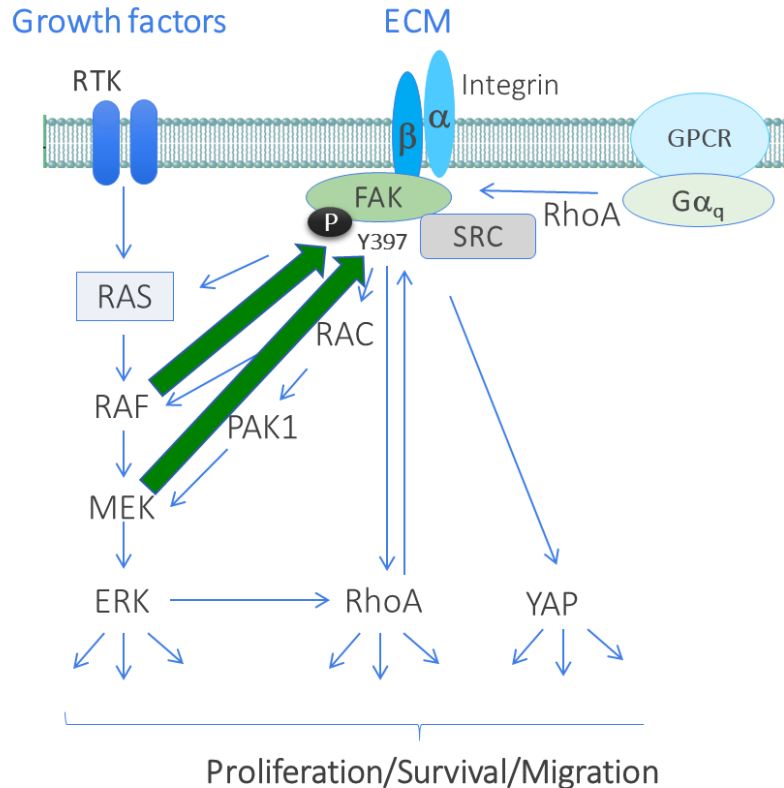

**➔ = Feedback
Reactivation**

p-FAK

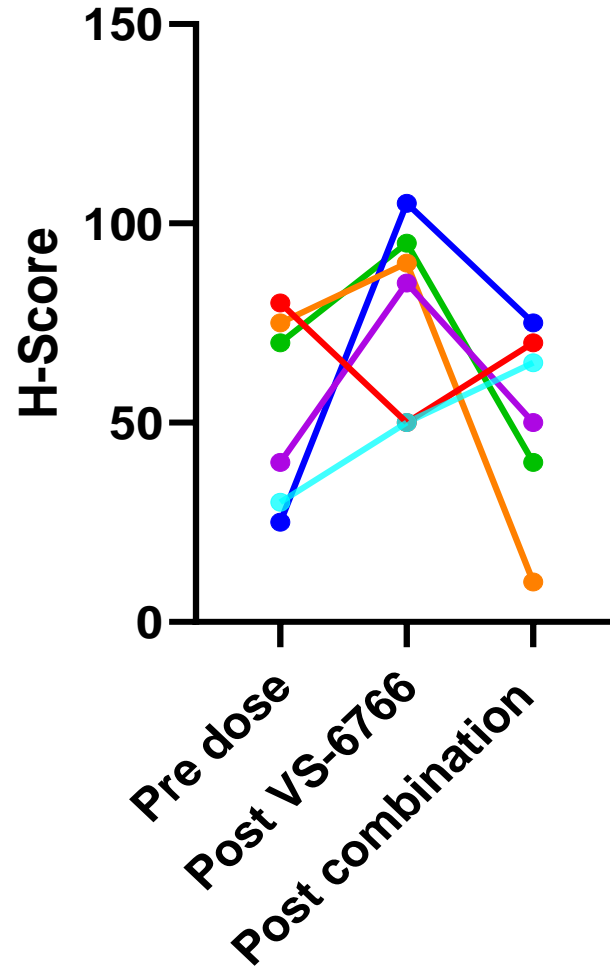

- **MEK inhibition induces compensatory activation of pFAK preclinically and clinically**
 - Trametinib induced ↑ pFAK (Y397) preclinically in KRAS mt NSCLC cell lines
 - **Also observed in patients**
 - **VS-6766 induced ↑ pFAK (Y397) as a potential resistance mechanism in the majority of patients**
 - **Combination with defactinib reduced this compensatory pFAK signal**

Pharmacokinetic Profiles of VS-6766 + Defactinib in Combination Similar to that seen in Single Agent Studies

VS-6766

Cohort	Dose (mg)	N	Subject	AUC _{0-24h} (h*ng/mL)	C _{max} (ng/mL)
1	3.2 (with 200mg VS)	3	Mean	6179	354
			CV%	32.1	30.4
2a	4 (with 200mg VS)	5	Mean	5353	289
			CV%	15.8	16.0
2b	3.2 (with 400mg VS)	1	FRA101-007	3302	229

Defactinib

Cohort	Dose (mg)	N	Subject	AUC _{last} (h*ng/mL)	C _{max} (ng/mL)
1	200 (with 3.2mg RO)	3	Mean	2071	273
			CV%	103	80
2a	200 (with 4mg RO)	5	Mean	2252	318
			CV%	124	117
2b	400 (with 3.2mg RO)	3	Mean	2807	360
			CV%	31	32

Target exposure for preclinical tumor regression is covered by twice weekly dosing of 4 mg VS-6766 3 wks on/1 wk off

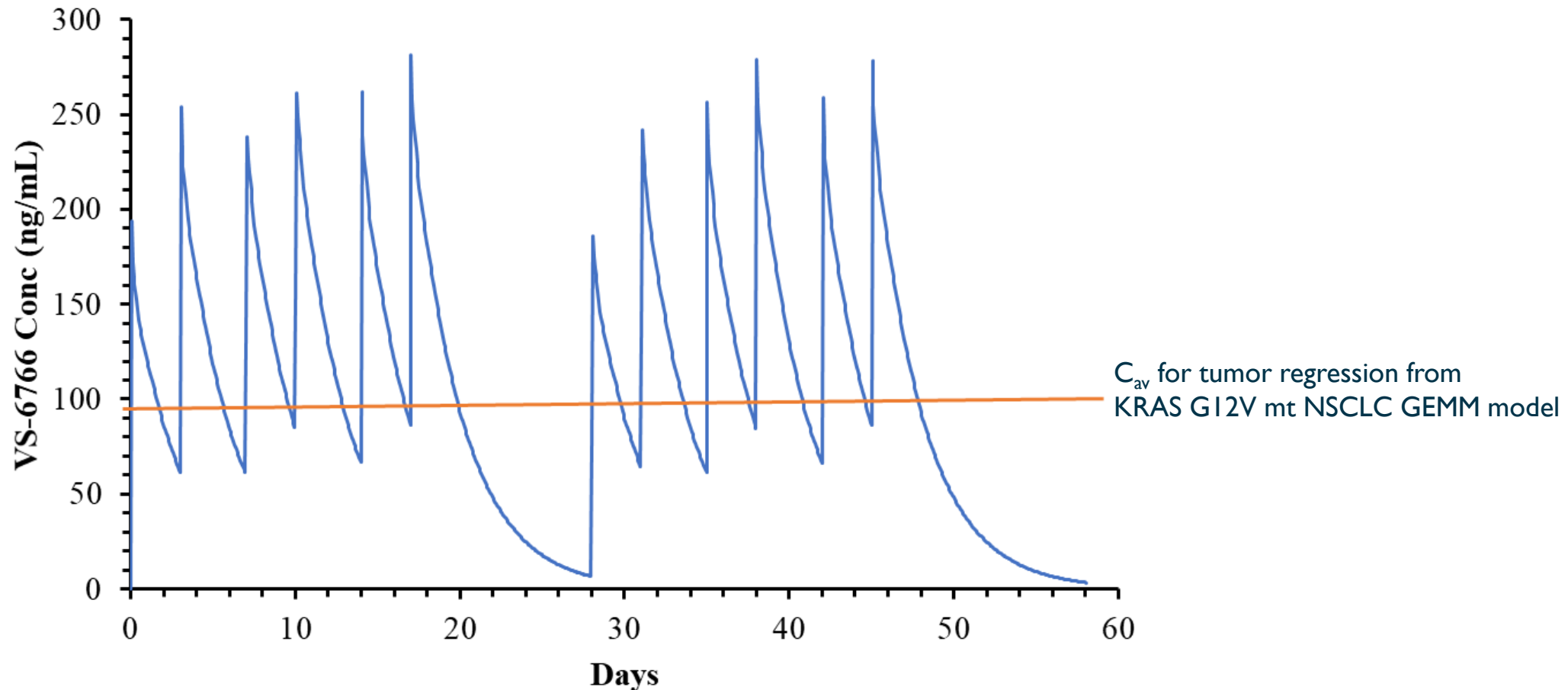

- Modeling of PK for 4 mg VS-6766 2/wk, 3 wks on/1 wk off, based on 4 mg single dose PK data (study NO21895)
- Relationship to average exposure for tumor regression in KRAS G12V mt NSCLC mouse model

Status: Combination of VS-6766 with Everolimus (mTOR inhibitor)

- Synergy of VS-6766 + everolimus observed broadly across cancer cell lines with various KRAS mutation variants
- A well-tolerated RP2D for VS-6766 + everolimus has been established with intermittent dosing of both agents (twice weekly; 3 wks on/1 wk off)
- KRAS mutant NSCLC expansion cohort is currently ongoing with VS-6766 + everolimus

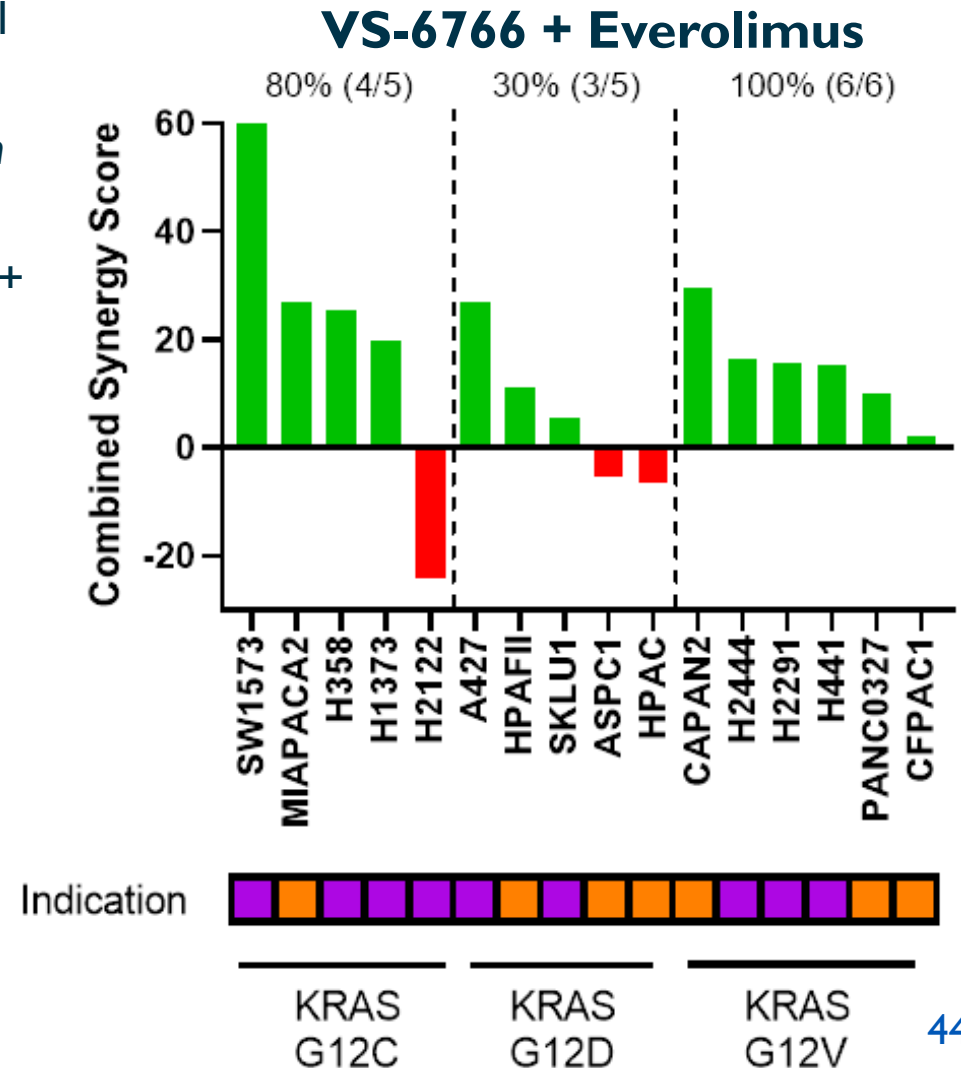
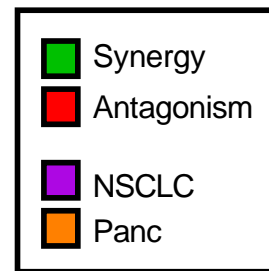

VS-6766 upregulates MHC Class I antigens on tumor cells: a mechanism for potentiation of I/O efficacy

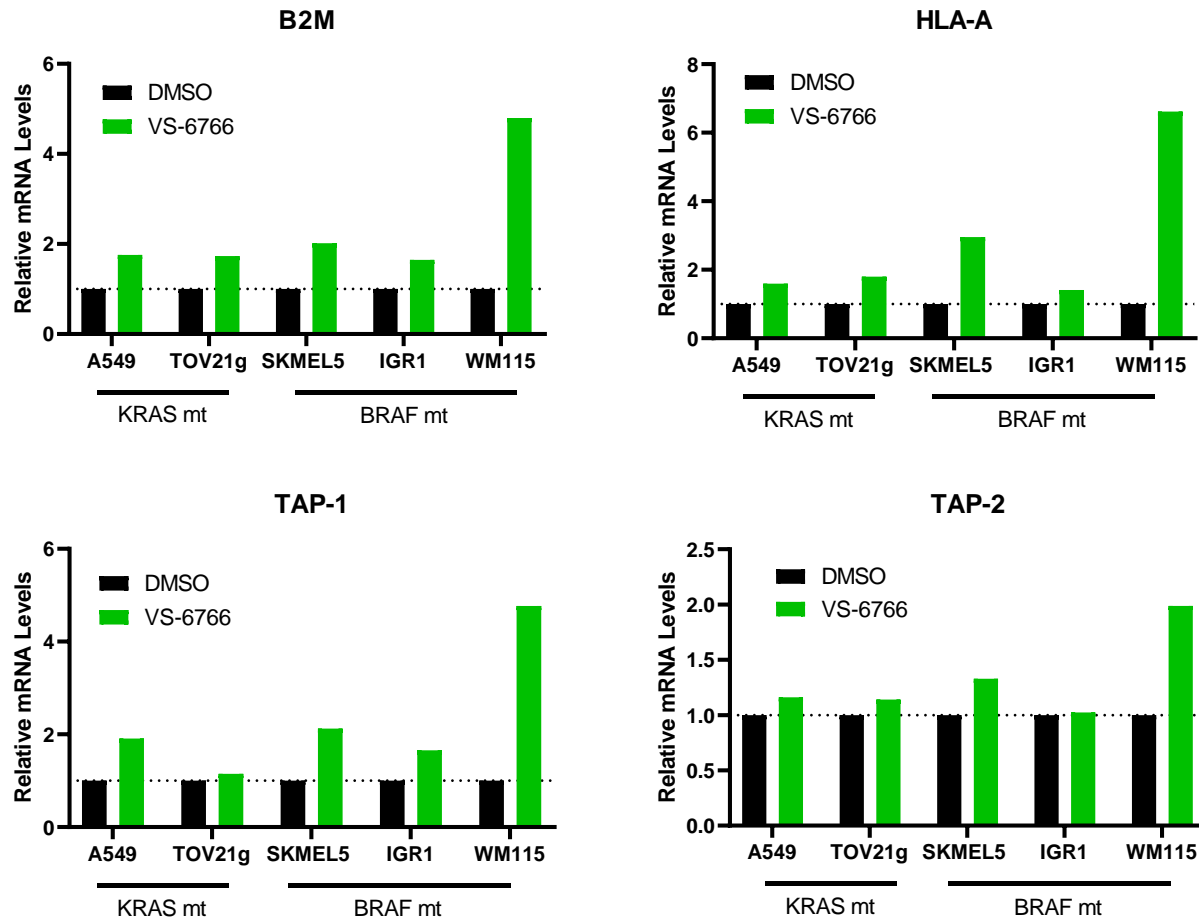

Cell Line	Tumor type	RAS/RAF mutation status
A549	Lung	KRASmut G12S
TOV21g	Ovarian	KRASmut G13C
SKMEL5	Melanoma	BRAFmut V600E
IGR-1	Melanoma	BRAFmut V600E
WM115	Melanoma	BRAFmut V600E

VS-6766 @ 1 μ M (except SKMEL5 and IGR-1, 300 nM)

VS-6766 enhances tumor growth inhibition when combined with anti-PD-1 in the CT26 KRAS (G12D) syngeneic model

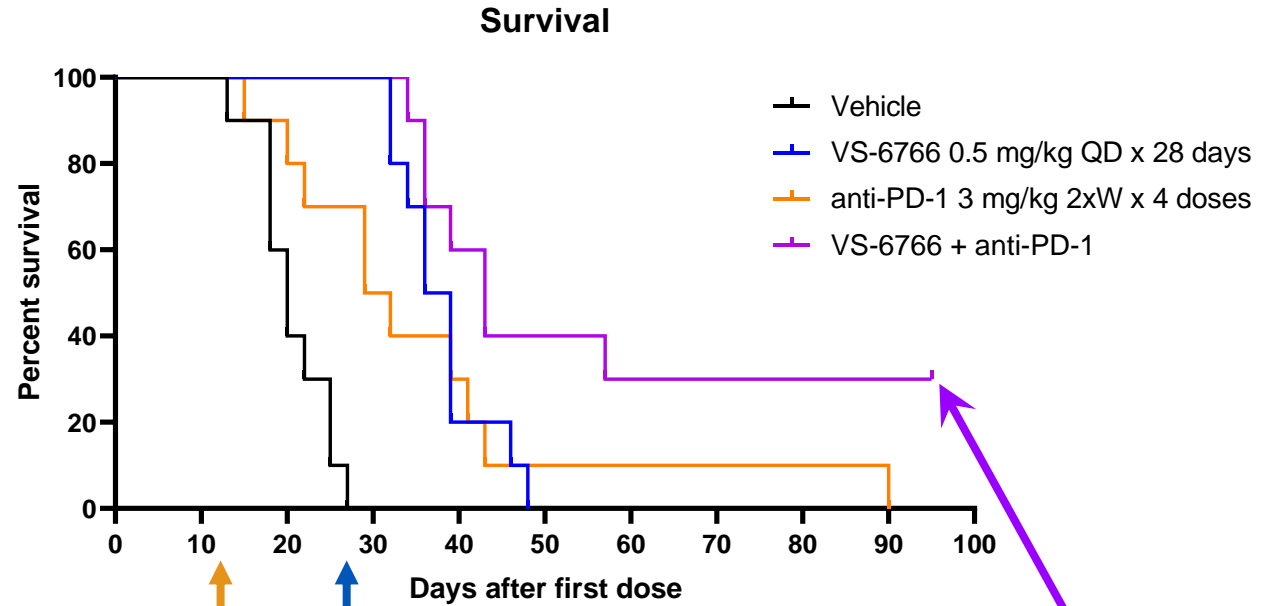
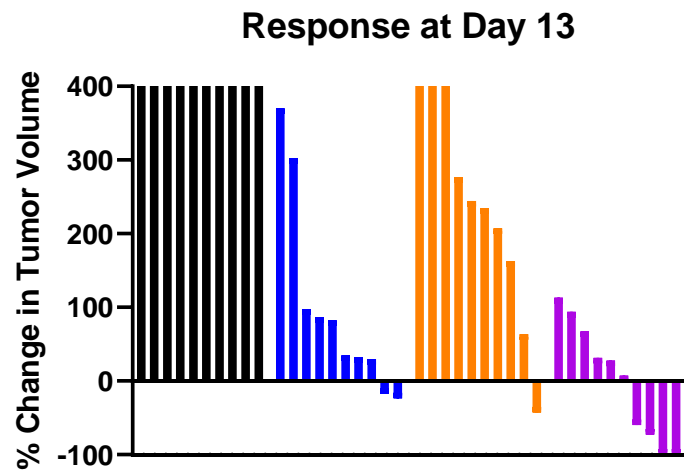
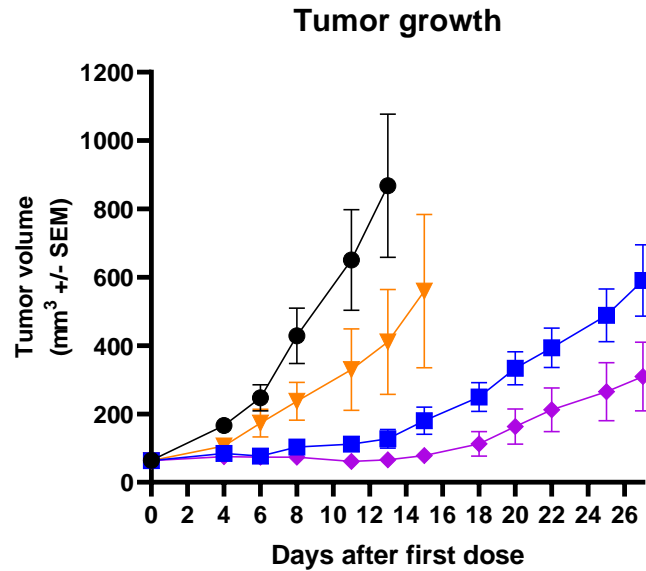

Day 11, Last dose anti-PD-1
 Day 28, Last dose VS-6766

- Vehicle
- VS-6766 0.5 mg/kg QD x 28 days
- anti-PD-1 3 mg/kg 2xW x 4 doses
- VS-6766 + anti-PD-1

Tumor re-challenge in tumor-free mice showed immune memory with increased memory T cells

LGSOC Market Opportunity – Reference Calculations

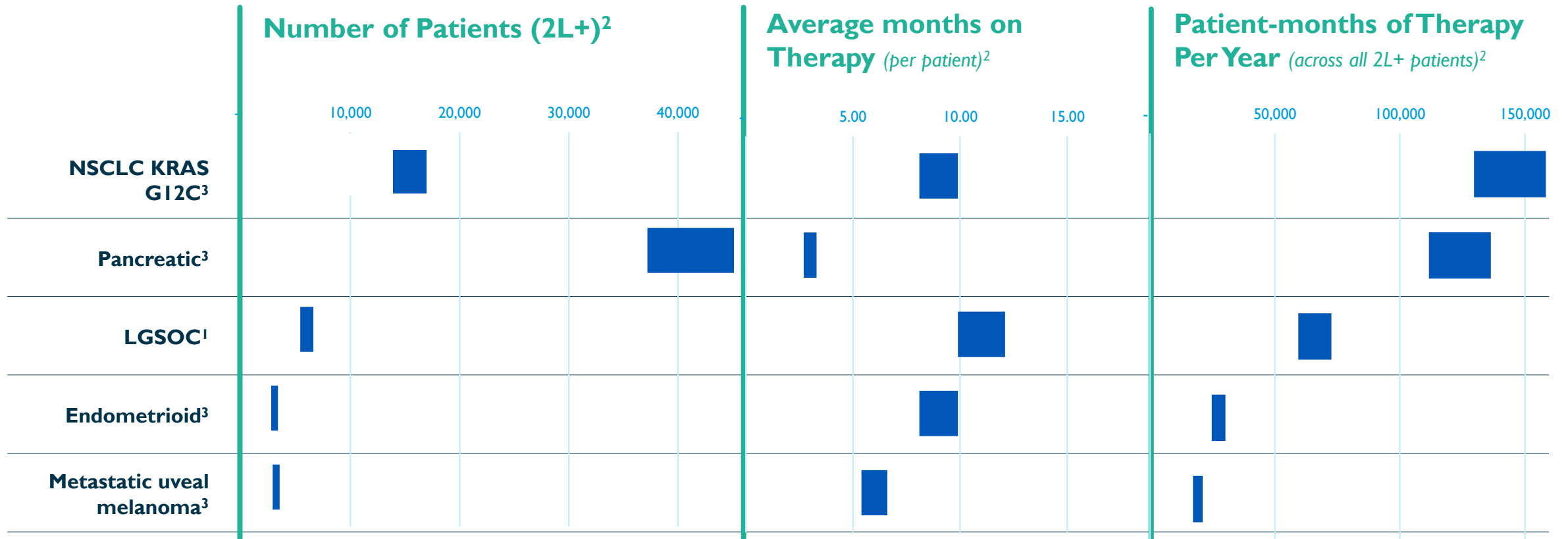

¹ Prevalence used for LGSOC patient population estimate. References: Monk, Randall, Grisham, The Evolving Landscape of Chemotherapy in Newly Diagnosed Advanced Epithelial Ovarian Cancer, Am Soc Clin Oncol Educ Book; 2019; Slomovitz, Gourley, Carey, Malpica, Shih, Huntsman, Fader., Grisham et al, Low-Grade serous ovarian cancer: State of the Science; Gynecol Oncol; 2020. Grisham, Iyer, Low-Grade Serous Ovarian Cancer: Current Treatment Paradigms and Future Directions; Curr Treat Options Oncology; 2018; Globocan 2020

² Patient-months of Therapy metric calculated by multiplying relevant incidence/prevalence rate times estimated duration of therapy; represents US market opportunity only; patient population estimates from Globocan 2020, American Cancer Society 2021, AACR Genie Cohort 9.0 public, and scientific publications. Duration of therapy estimates from clinical studies and clinician experience. Number of patients and months on therapy are for 2nd-line+

³ NSCLC KRAS G12C 2nd line patients (incidence); Pancreatic RAS/RAF mutant 2nd-line patients (incidence); Endometrioid RAS/RAF mutant 2nd-line patients (incidence); Uveal melanoma RAS/RAF mutant 2nd-line patients (incidence)

A drug with a Breakthrough designation will have⁽¹⁾...

- Increased communication with FDA during drug development and review
- FDA guidance to ensure that the design of clinical trials are as efficient as practicable
- A cross-disciplinary project lead assigned to the FDA review team and increased involvement of senior managers and experienced review staff
- Based on the criteria for the grant of breakthrough designation, may represent substantial improvement over existing clinical therapies

List of Oncology Drugs that Received Breakthrough Therapy Designation

Sr no.	Proprietary Name	Established Name	Current Approval Status	Company
1.	Zykadia	Ceritinib	Approved	Novartis
2.	Ibrance	Palbociclib	Approved	Pfizer
3.	Keytruda	Pembrolizumab	Approved	Merck
4.	Opdivo	Nivolumab	Approved	Bristol Myers Squibb
5.	Tagrisso	Osimertinib	Approved	Lilly
6.	Alecensa	Alectinib	Accelerated Approval	Genentech
7.	Xalkori	Crizotinib	Approved	Pfizer
8.	Lenvima	Lenvatinib	Approved	Eisai
9.	Tecentriq	Atezolizumab	Approved	Genentech
10.	Rubraca	Rucaparib	Approved	Clovis Oncology
11.	Kisqali	Ribociclib	Approved	Novartis
12.	Zejula	Niraparib	Approved	GSK
13.	Alunbrig	Brigatinib	Accelerated Approval	Takeda
14.	Kisqali Femara Co-Pack	Letrozole & Ribociclib	Approved	Novartis
15.	Tafinlar	Dabrafenib	Approved	Novartis
16.	Mekinist	Trametinib	Approved	Novartis
17.	Verzenio	Abemaciclib	Approved	Lilly
18.	Imfinzi	Durvalumab	Approved	AstraZeneca
19.	Yervoy	Ipilimumab	Approved	Bristol Myers Squibb
20.	Azedra	lobenguane	Approved	Progenics Pharmaceuticals
21.	Lorbrena	Lorlatinib	Approved	Pfizer
22.	Kadcyla	Ado-trastuzumab emtansine	Approved	Genentech
23.	Padcev	Enfortumab vedotin-ejfv	Approved	Astellas Pharma
24.	Enhertu	Fam-trastuzumab deruxtecan- nxki	Approved	Daiichi-Sankyo
25.	Jelmyto	Mitomycin	Approved	UroGen Pharma
26.	Tukysa	Tucatinib	Approved	Seagen
27.	Trodelyv	Sacituzumab Govitecan-hziy	Approved	Gilead
28.	Tabrecta	Capmatinib	Approved	Novartis
29.	Retevmo	Selpercatinib	Approved	Lilly
30.	Gavreto	Pralsetinib	Approved	Blueprint medicines
31.	N/A	VS6766/Defactinib	Not yet approved	Verastem
32.	Lumakras	Sotorasib	Accelerated Approval	Amgen
33.	N/A	177Lu-PSMA-617	Not yet approved	Novartis
34.	Ayvakit	Avapritinib	Approved (Mast Cell Leukemia)	Blueprint Medicines Corp
35.	N/A	Adagrasib	Not yet approved (NSCLC)	Mirati Therapeutics, Inc.

Strong Patent Protection

- COM for VS-6766 to 2027 & defactinib to 2028, Hatch Waxman should extend to 2032
- VS-6766 intermittent dosing regimen until 2038 if granted
- FAK/MEK combination to 2035
- VS-6766/defactinib combination until 2040 if granted
- Method of manufacture for VS-6766 to 2032
- Other activity related to patent protection is ongoing and will continue into the future

Experienced Senior Management Team



Brian Stuglik
Chief Executive Officer

- Global VP & Chief Marketing Officer – Lilly Oncology
- Founding Member – Proventus Health Solutions



Daniel Paterson
President and Chief Operating Officer

- CEO – The DNA Repair Co. (now On-Q-ity)
- PharMetrics (now IMS), Axion



Rob Gagnon
Chief Business and Financial Officer

- CFO – Harvard Bioscience, Clean Harbors
- VP of Finance – Biogen Idec



Cathy Carew
Chief People & Organizational Strategy Officer

- Principal – HR Collaborative
- Ironwood, ActiveBiotics, Dynogen, Tufts Health Plan



Jonathan Pachter, Ph.D.
Chief Scientific Officer

- Head of Cancer Biology – OSI (now Astellas)



Hagop Youssofian, MSc, M.D.
Head of Medical Strategy

- CMO, BIND Therapeutics, EVP, Progenics,
- CMO & EVP, Ziopharm Oncology, SVP, Imclone



THANK YOU